

1

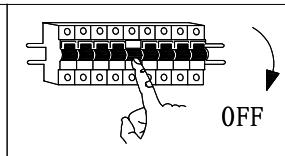

2

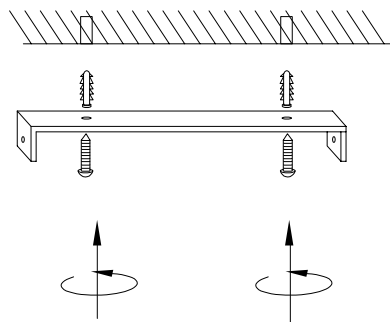
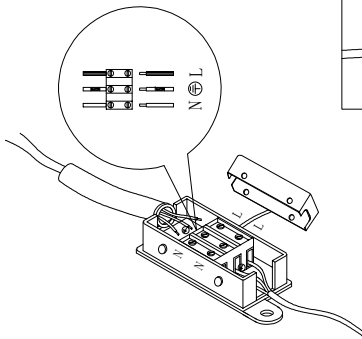

3

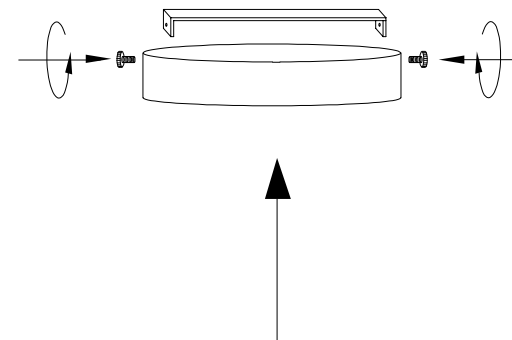

4

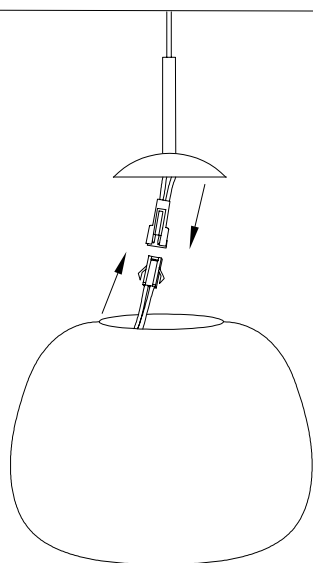

5

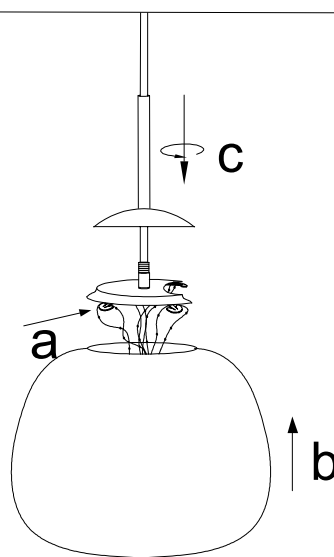

6

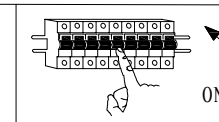
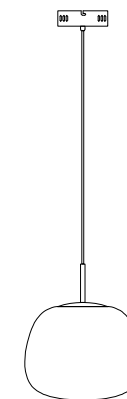

8W LED DC 24V  
220-240V~50/60Hz

GLOBO Handels GmbH  
Gewerbestr. 3  
A-9184 Sankt Peter  
AUSTRIA  
www.globo-lighting.com  
office@globo-lighting.com

# Anleitung zum Auswechseln der LEDs/ Instruction how to change the LEDs

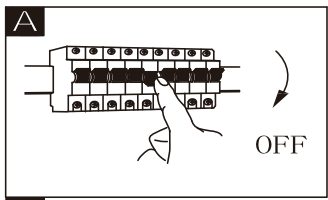

B

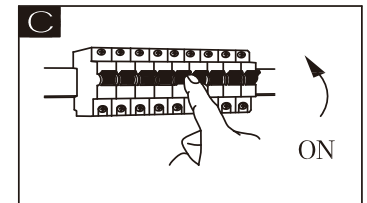
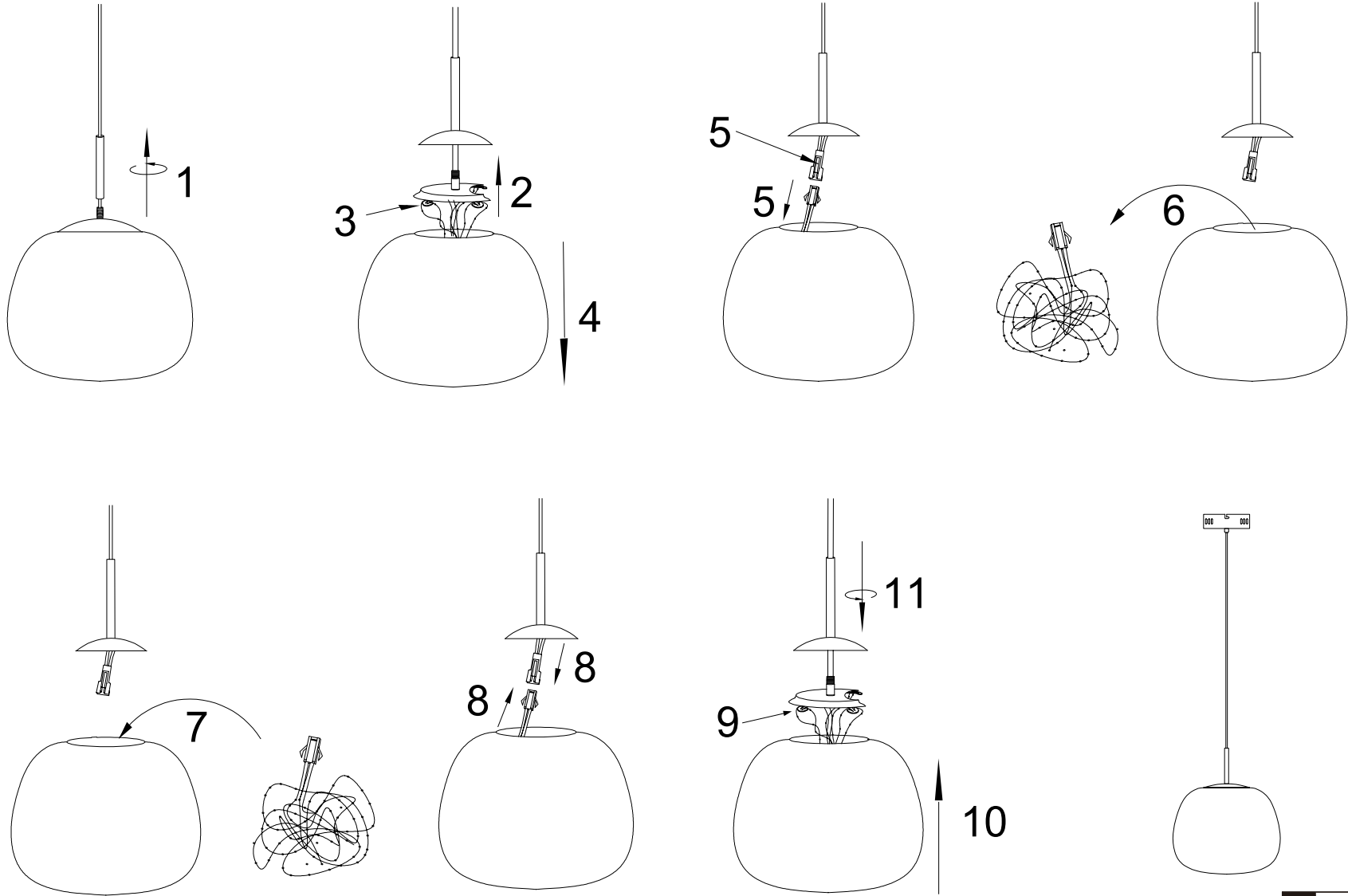

Lichtquelle/Light source:



DEU:

Lichtquelle:

Dieses Produkt enthält eine Lichtquelle der Energieeffizienzklasse <F>.



Die LED - Lichtquelle kann nur durch einen Fachmann ausgetauscht werden.

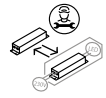

Das Betriebsgerät kann nur durch einen Fachmann ausgetauscht werden.

GBR:

Light source:

This product contains a light source of energy efficiency class <F>.



The LED - light source can only be replaced by a professional.

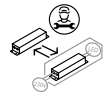

The control gear can be replaced by a professional.

BIH:

Izvor svjetla :

Ovaj proizvod sadržava izvor svjetlosti klase energetske učinkovitosti <F>.



LED – izvor svjetla smije zamjeniti samo stručna osoba.

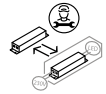

Pogonski uređaj smije zamjeniti samo stručna osoba.

BG:

Източник на светлина:

Този продукт включва светлинен източник с клас на енергийна ефективност <F>.



LED източникът на светлина може да се подменя само от специалист.

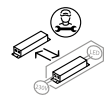

Устройството за управление може да се подменя само от специалист.

CZ:

Zdroj světla:

Tento výrobek obsahuje světelný zdroj s třídou energetické účinnosti <F>.

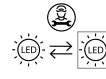

Výměna světelného LED zdroje pouze odborníkem.

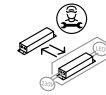

Výměna předřadníku pouze odborníkem.

DK:

Lyskilde:

Dette produkt indeholder en lyskilde i energieeffektivitetsklasse <F>.

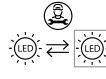

LED- lyskilden kan kun skiftes af en fagperson.

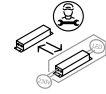

Driftsenheden kan kun skiftes af en fagperson.

ET:

Valgusallikas:

Toode sisaldab energiatõhususe klassi <F> valgusallikat.

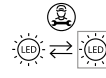

LED - valgusallikat võib vahetada ainult professionaal.

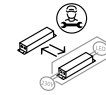

Juhtseadmed võib asendada professionaalne.

FI:

Valonlähde:

Tämä tuote sisältää valonlähteen, jonka energiatehokkuusluokka on <F>.

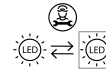

Vain ammattihenkilö voi vaihtaa LED-valonlähteen.

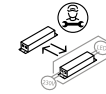

Vain ammattihenkilö voi vaihtaa liitäntälaitteen.

FR:

Source lumineuse:

Ce produit contient une source lumineuse de classe d'efficacité énergétique <F>.

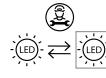

La source lumineuse LED ne peut être remplacée que par un spécialiste.

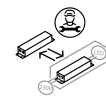

L'unité de contrôle ne peut être remplacée que par un spécialiste.

**GR:**

**Φωτεινή πηγή:**

Το προϊόν αυτό περιέχει φωτεινή πηγή της τάξης ενεργειακής απόδοσης <F>.

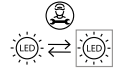

Η φωτεινή πηγή LED μπορεί να αντικατασταθεί μόνο από έναν ειδικό.

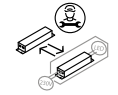

Η λειτουργική συσκευή μπορεί να αντικατασταθεί μόνο από έναν ειδικό.

**HU:**

**Fényforrás:**

Ez a termék egy <F> energiahatékonysági osztályú fényforrást tartalmaz.

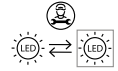

A LED fényforrás cseréjét csak szakemberek végezhetik.

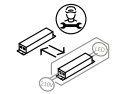

Az előtétet csak szakértők cserélhetik ki.

**IS:**

**Ljósgrafi:**

Varan inniheldur ljósgjafa í orkuflokki <F>.

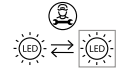

Aðeins fagmenn mega skipta um LED-ljósgjafann.

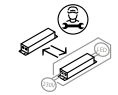

Aðeins fagmenn mega skipta um stjórnbúnaðinn.

**IT:**

**Sorgente luminosa:**

Questo prodotto contiene una sorgente luminosa di classe di efficienza energetica <F>.



La sorgente luminosa a LED può essere sostituita solo da personale specializzato.

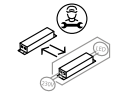

L'alimentatore può essere sostituito solo da personale specializzato.

**HR :**

**Izvor svjetla :**

Ovaj proizvod sadržava izvor svjetlosti klase energetske učinkovitosti <F>.

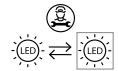

LED – izvor svjetla smije zamjeniti samo stručna osoba.

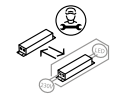

Pogonski uređaj smije zamjeniti samo stručna osoba.

**LV:**

**Gaismas avots:**

Šis ražojums satur gaismas avotu, kura energoefektivitātes klase ir <F>.

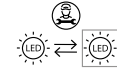

LED apgaismes līdzekli var nomainīt speciālists.

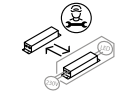

Vadības ierīci var nomainīt speciālists.

**LT:**

**Šviesos šaltinis:**

Šiame gaminyje yra šviesos šaltinis, kurio energijos vartojimo efektyvumo klasė <F>.

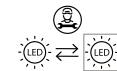

LED šviesos šaltinį gali pakeisti tik tam kvalifikuotas specialistas.

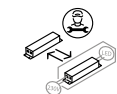

Valdymo įtaisą gali pakeisti tik tam kvalifikuotas specialistas.

**NL:**

**Lichtbron:**

Dit product bevat een lichtbron van energie-efficiëntieklasse <F>.

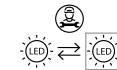

De LED-lichtbron kan alleen door een vakman worden vervangen.

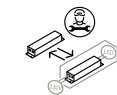

Het apparaat kan alleen door een vakman worden vervangen.

**NO:**

**Lyskilde:**

Denne produktet inneholder en lyskilde i energiklasse <F>.

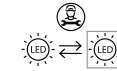

LED-lyspæren kan kun byttes av fagmann.

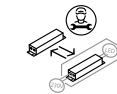

Driverenheten kan kun byttes av fagmann.

**PL:**

**Źródło światła:**

Ten produkt zawiera źródło światła o klasie efektywności energetycznej <F>.

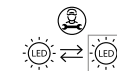

LED - źródło światła może być wymienione tylko przez profesjonalistę.

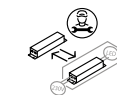

Urządzenie sterujące może zostać wymienione przez specjalistę.

**PT:**

**Fonte de Luz:**

Este produto contém uma fonte de luz da classe de eficiência energética <F>.

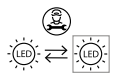

Substituição da LED por um profissional.

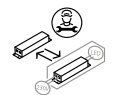

Substituição do equipamento de controlo por um profissional.

**RO:**

**Sursa de lumina:**

Acest produs conține o sursă de lumină cu clasa de eficiență energetică <F>.

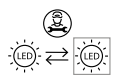

Sursa LED poate fi înlocuită/schimbata doar de către personal specializat.

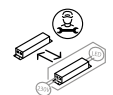

Driverul poate fi înlocuit doar de către personal specializat

**RUS:**

**Источник света:**

Данный продукт содержит источник света класса энергоэффективности <F>.

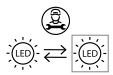

Светодиодный источник света может заменяться только квалифицированным специалистом.

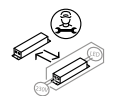

Устройство управления может заменяться только квалифицированным специалистом.

**SRB:**

**Izvor svetlosti:**

Ovaj proizvod sadrži izvor svetlosti klase energetske efikasnosti <F>.

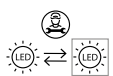

LED izvor svetlosti može da zameni samo specijalista.

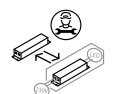

Upravljački uređaj može da zameni samo specijalista.

**SK:**

**Zdroj svetla:**

Tento výrobok obsahuje svetelný zdroj triedy energetickej účinnosti <F>.

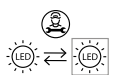

Výmena svetelného LED zdroja len odborníkom.

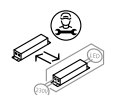

Výmena predradníka len odborníkom.

**SI:**

**Izvor svetlobe:**

Ta izdelek vsebuje svetlobni vir razreda energijske učinkovitosti <F>.

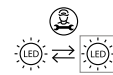

Svetlobni vir lahko zamenja samo strokovno usposobljena oseba.

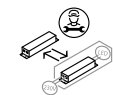

Krmilno napravo lahko zamenja samo strokovno usposobljena oseba

**ES:**

**Fuente de luz:**

Este producto contiene una fuente luminosa de la clase de eficiencia energética <F>.

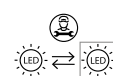

Sustitución del chip LED por un profesional.



Sustitución del aparato por un profesional.

**SE:**

**Ljuskälla:**

Denna produkt innehåller en ljuskälla med energieffektivitetsklass <F>.

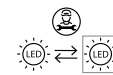

LED-ljuskällan kan endast bytas ut av en fackman.

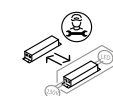

Driftdonet kan endast bytas ut av en fackman.

**TR:**

**Işık kaynağı:**

Bu ürün, <F> enerji sınıfından bir ışık kaynağına sahiptir.

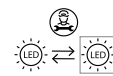

LED ışık kaynağı, sadece bir uzman tarafından değiştirilebilir.

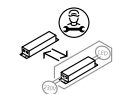

İşletme cihazı sadece bir uzman tarafından değiştirilebilir.

**UK:**

**Джерело світла:**

Цей виріб містить джерело світла класу енергоефективності <F>.



лише фахівець може замінювати джерело світлодіодного світла.



лише фахівець може замінювати пристрій керування