

# GLOBO

LIGHTING

B

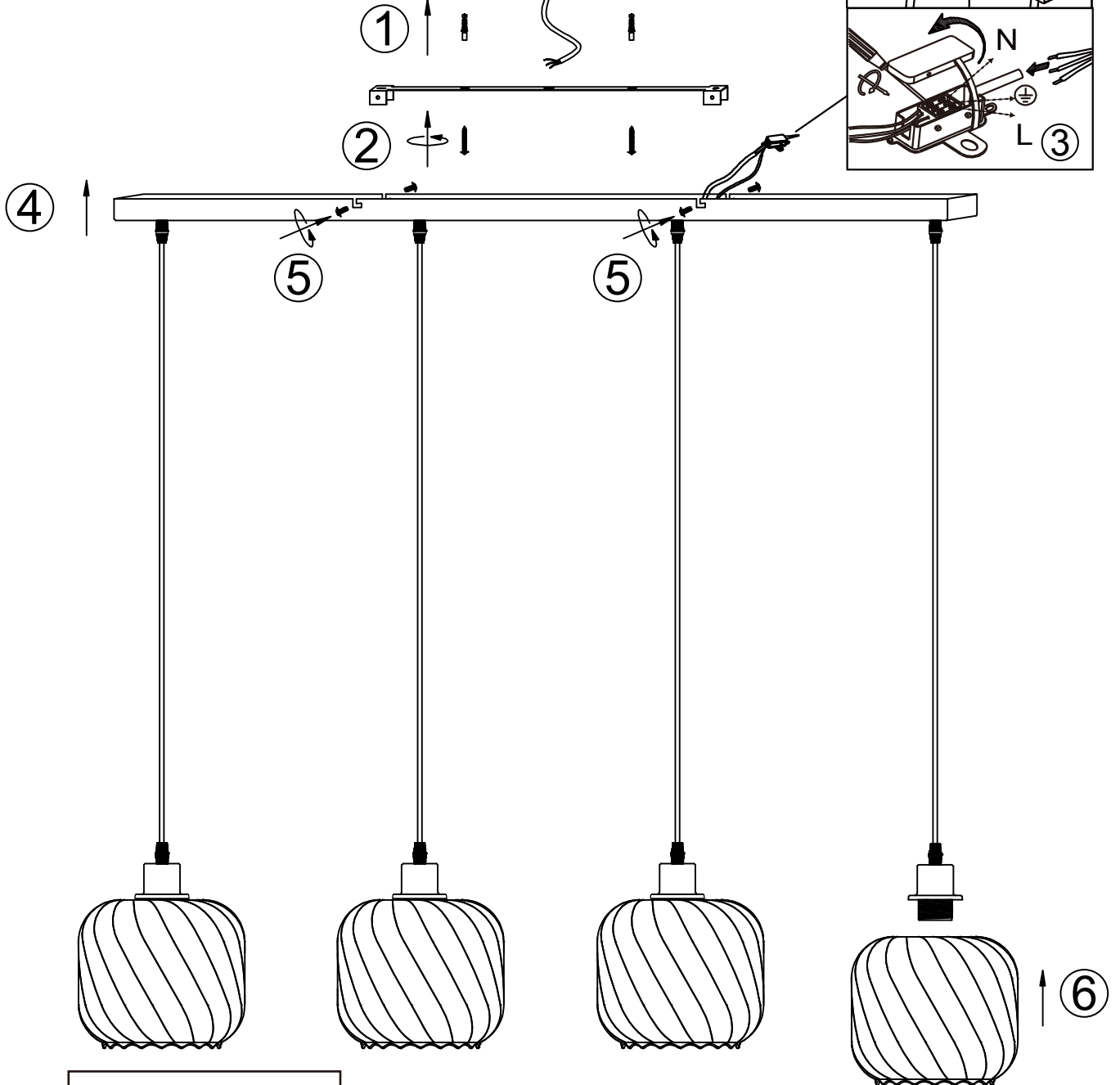
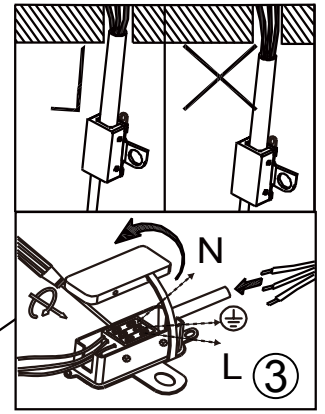

4 x Max 25W E27  
230V~ 50Hz

## 15754-4H

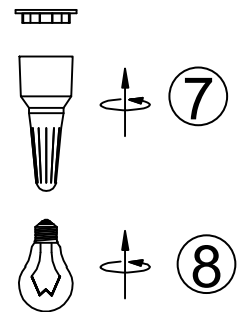

GLOBO Handels GmbH  
Gewerbestr. 3  
A-9184 Sankt Peter  
Austria  
[www.globo-lighting.com](http://www.globo-lighting.com)  
[office@globo-lighting.com](mailto:office@globo-lighting.com)

