

# GLOBO

LIGHTING

**A**

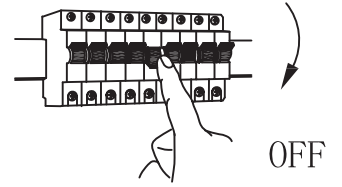

**B**

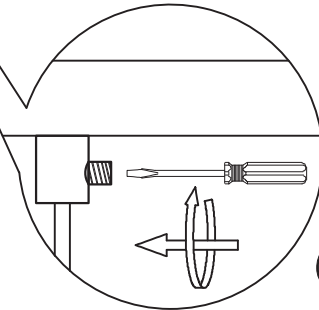
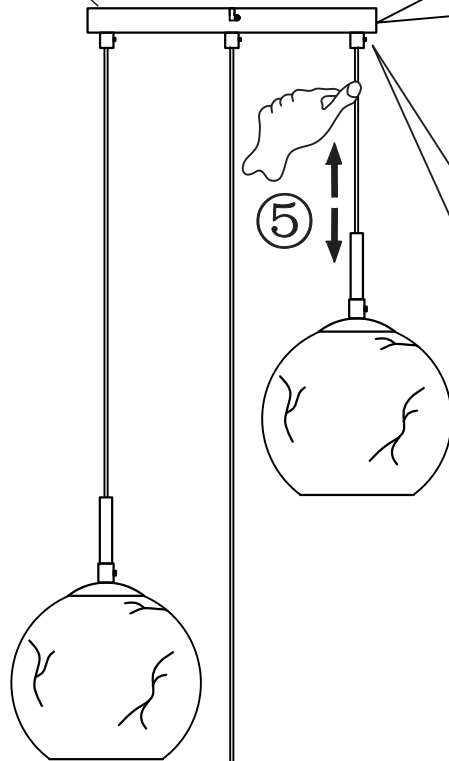
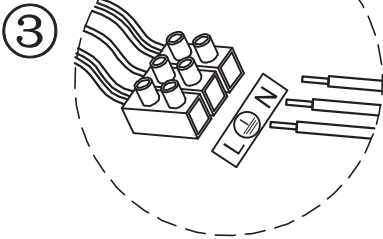
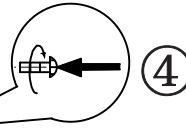
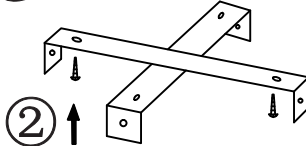
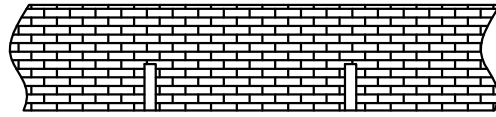

3 × max 60W E27  
230V ~ 50Hz

GLOBO Handels GmbH  
Gewerbestr. 3  
A-9184 Sankt Peter  
AUSTRIA  
www.globo-lighting.com  
office@globo-lighting.com

**C**

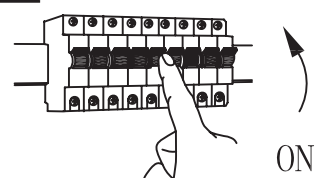

**15999M-3HR**

