

GLOBO

LIGHTING

17019H1/17019H1S/17019H1SA

B

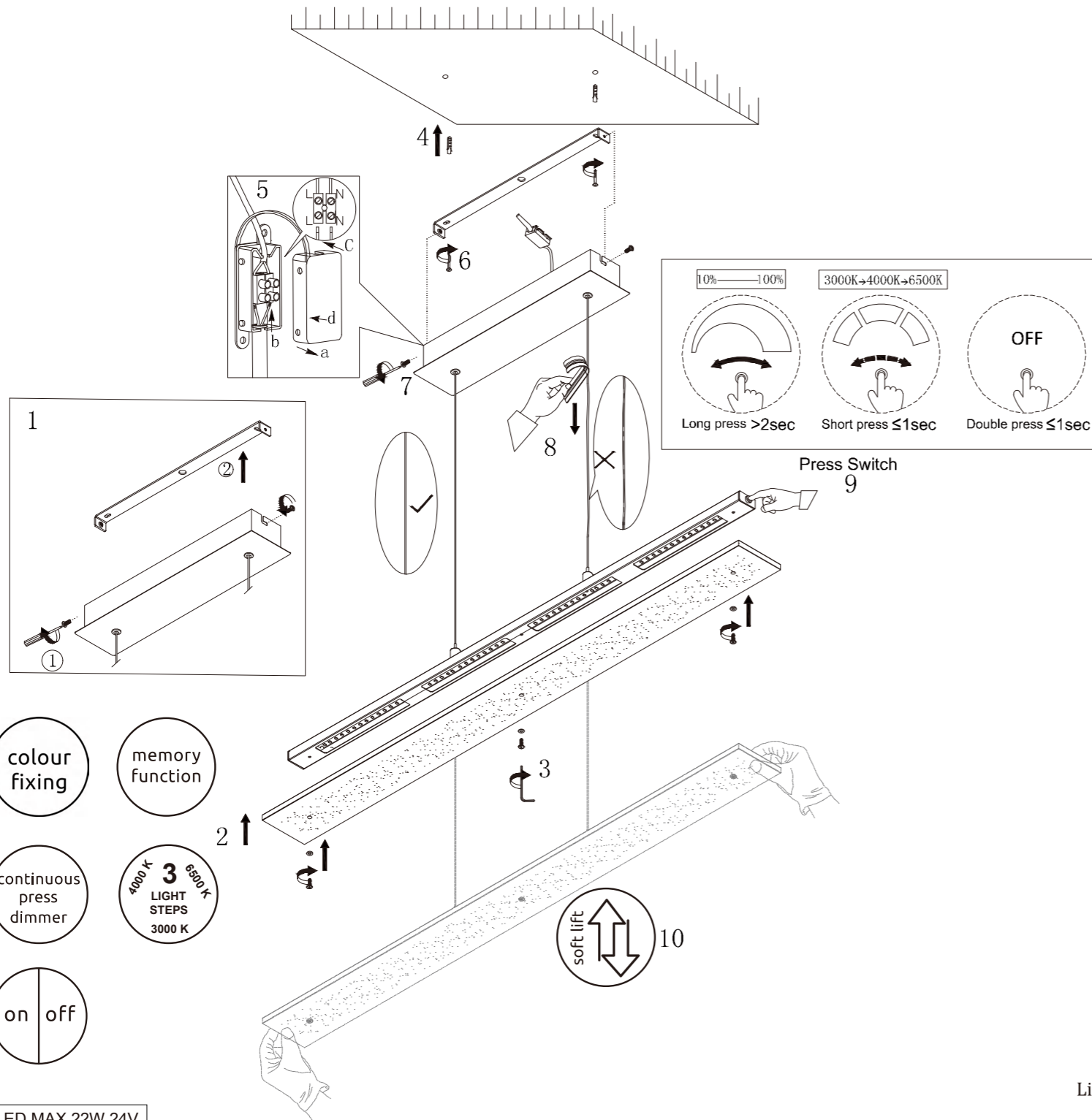

LED MAX 22W 24V
230V~ 50/60Hz

GLOBO Handels GmbH
Gewerbestr. 3, A-9184 Sankt Peter, AUSTRIA
www.globo-lighting.com | office@globo-lighting.com

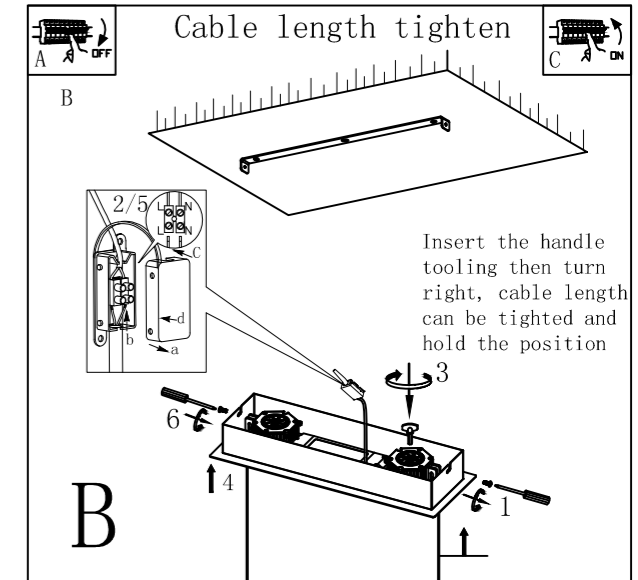
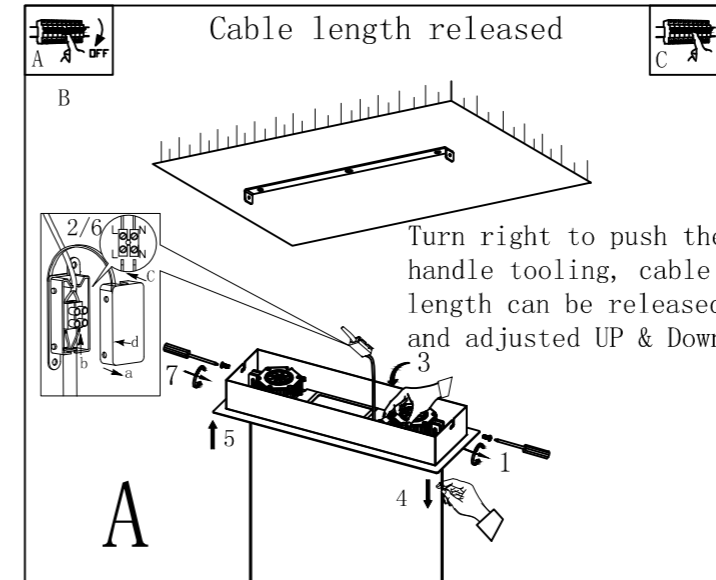
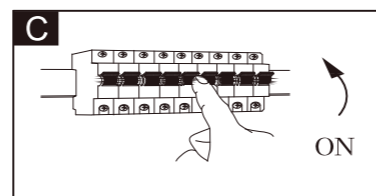

Light source disassembly diagram

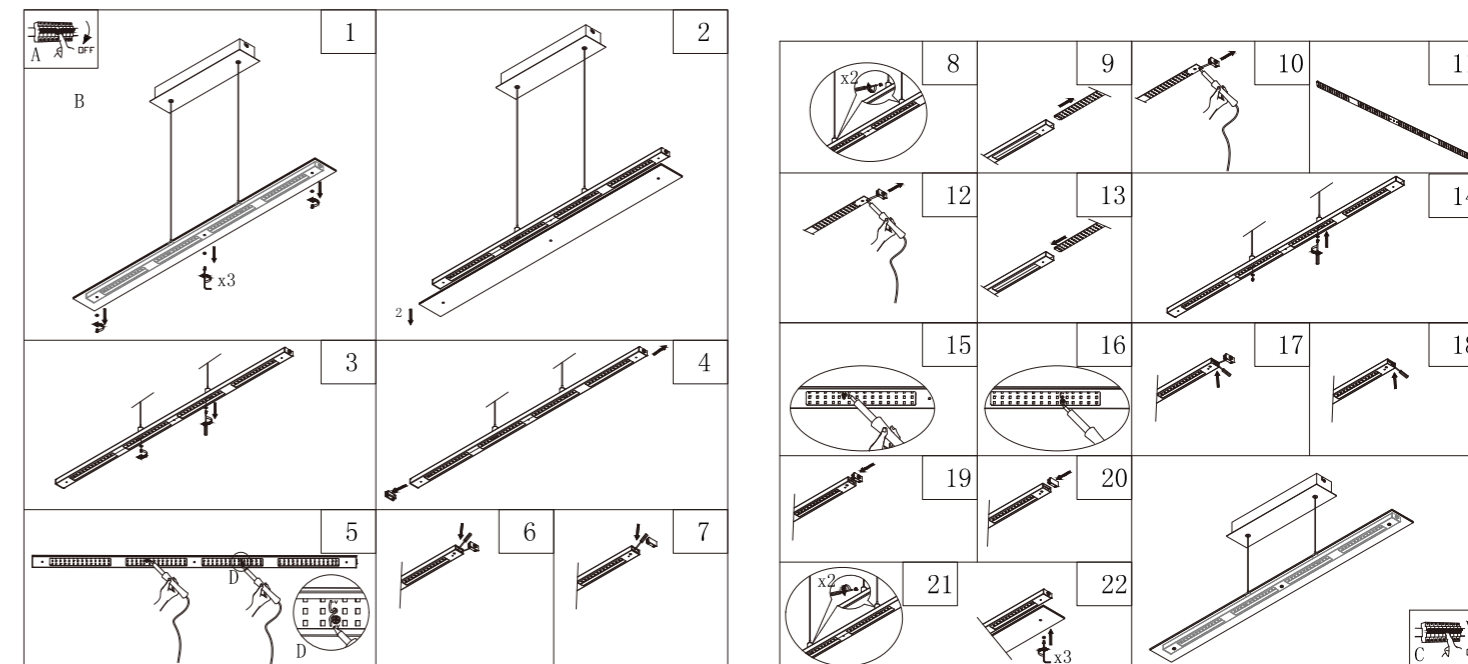

Lichtquelle/Light Source:

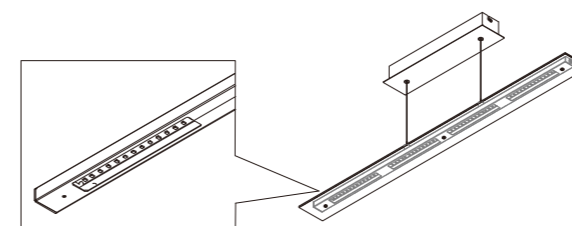

DEU:
Lichtquelle:
Dieses Produkt enthält eine Lichtquelle der Energieeffizienzklasse <F>.

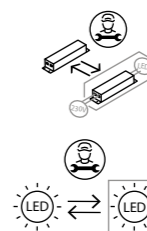

Das Betriebsgerät kann nur durch einen Fachmann ausgetauscht werden.

Die LED - Lichtquelle kann nur durch einen Fachmann ausgetauscht werden.

GBR:
Light source:
This product contains a light source of energy efficiency class <F>.

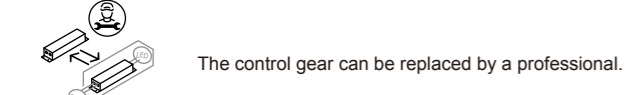

The control gear can be replaced by a professional.

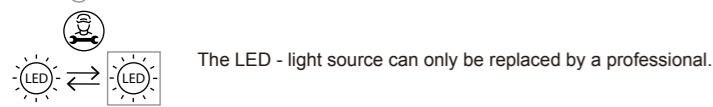

The LED - light source can only be replaced by a professional.

BIH:
Izvor svjetla :
Ovaj proizvod sadrži izvora svjetlosti klase energetske učinkovitosti <F>.

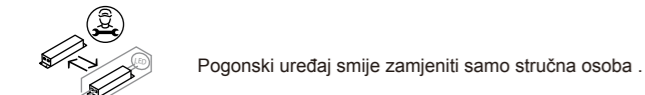

Pogonski uređaj smije zamjeniti samo stručna osoba .

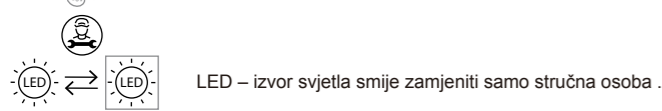

LED – izvor svjetla smije zamjeniti samo stručna osoba .

BG:
Източник на светлина:
Този продукт включва светлинен източник с клас на енергийна ефективност <F>.

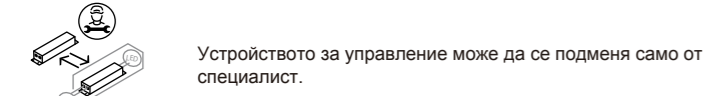

Устройството за управление може да се подменя само от специалист.

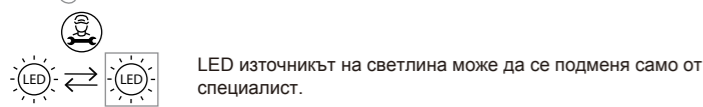

LED източникът на светлина може да се подменя само от специалист.

CZ:
Zdroj světla:
Tento výrobek obsahuje světelný zdroj s třídou energetické účinnosti <F>.

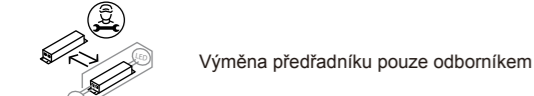

Výměna předřadníku pouze odborníkem

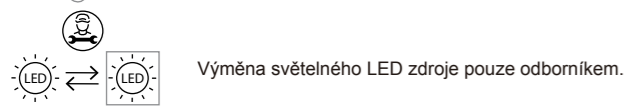

Výměna světelného LED zdroje pouze odborníkem.

DK:
Lyskilde:
Dette produkt indeholder en lyskilde i energieeffektivitetsklasse <F> .

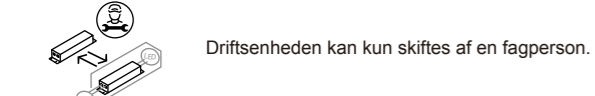

Driftsenheden kan kun skiftes af en fagperson.

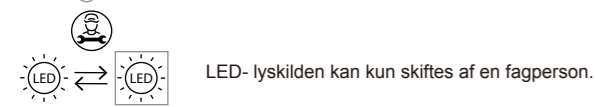

LED- lyskilden kan kun skiftes af en fagperson.

ET:
Valgusallikas:
Toode sisaldab energiatõhususe klassi <F> valgusallikat.

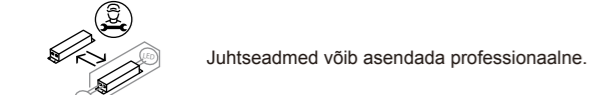

Juhtseadmed võib asendada professionaalne.

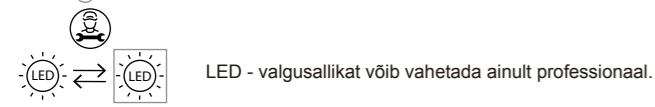

LED - valgusallikat võib vahetada ainult professionaal.

FI:
Valonlähde:
Tämä tuote sisältää valonlähteen, jonka energiatehokkuusluokka on <F>.

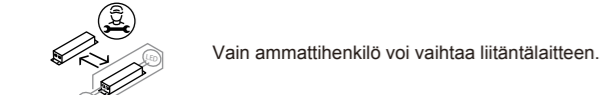

Vain ammattihenkilö voi vaihtaa liitäntälaitteen.

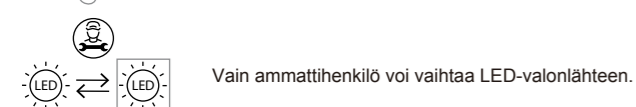

Vain ammattihenkilö voi vaihtaa LED-valonlähteen.

FR:
Source lumineuse:
Ce produit contient une source lumineuse de classe d'efficacité énergétique <F>.

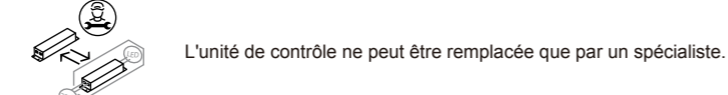

L'unité de contrôle ne peut être remplacée que par un spécialiste.

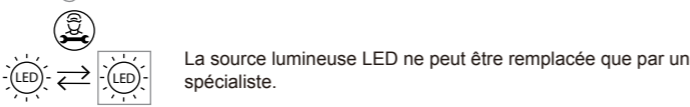

La source lumineuse LED ne peut être remplacée que par un spécialiste.

GR:
Φωτεινή πηγή:
Το προϊόν αυτό περιέχει φωτεινή πηγή της τάξης ενεργειακής απόδοσης <F>.

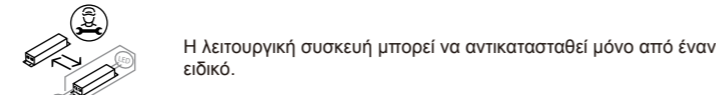

Η λειτουργική συσκευή μπορεί να αντικατασταθεί μόνο από έναν ειδικό.

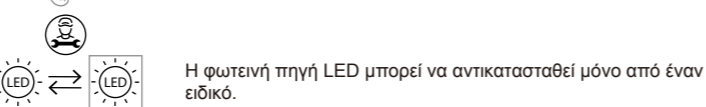

Η φωτεινή πηγή LED μπορεί να αντικατασταθεί μόνο από έναν ειδικό.

HU:
Fényforrás:
Ez a termék egy <F> energiatékonysági osztályú fényforrást tartalmaz.

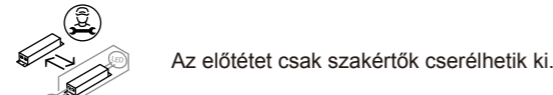

Az előtétet csak szakértők cserélhetik ki.

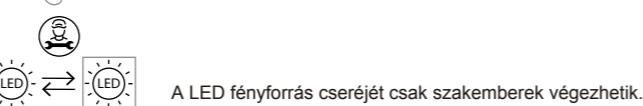

A LED fényforrás cseréjét csak szakemberek végezhetik.

Isländisch/IS:
Ljósgrjafi:
Varan inniheldur ljósgrjafa í orkuflokki <F>.

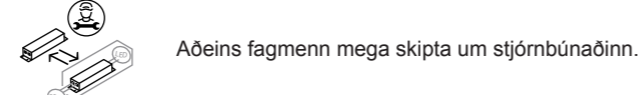

Aðeins fagmenn mega skipta um stjórnbúnaðinn.

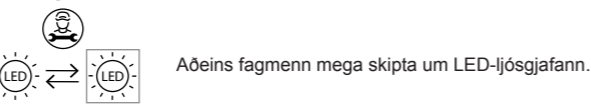

Aðeins fagmenn mega skipta um LED-ljósgrjafann.

IT:
Sorgente luminosa:
Questo prodotto contiene una sorgente luminosa di classe di efficienza energetica <F>.

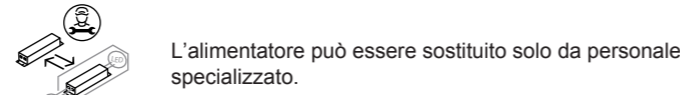

L'alimentatore può essere sostituito solo da personale specializzato.

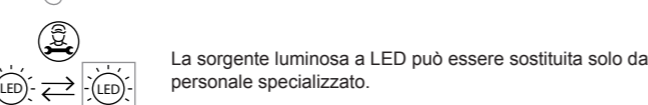

La sorgente luminosa a LED può essere sostituita solo da personale specializzato.

HR:
Izvor svjetla:
Ovaj proizvod sadrži izvora svjetlosti klase energetske učinkovitosti <F>.

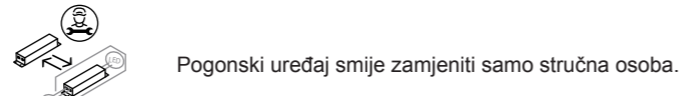

Pogonski uređaj smije zamjeniti samo stručna osoba.

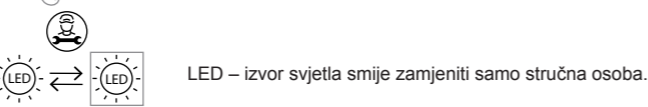

LED – izvor svjetla smije zamjeniti samo stručna osoba.

LV:
Gaismas avots:
Šis ražojums satur gaismas avotu, kura energoefektivitātes klase ir <F>.

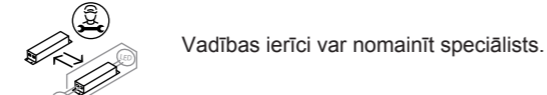

Vadības ierīci var nomainīt speciālists.

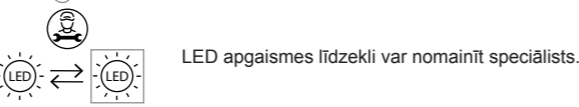

LED apgaismes līdzekli var nomainīt speciālists.

LT:
Šviesos šaltinis:
Šiame gaminyje yra šviesos šaltinis, kurio energijos vartojimo efektyvumo klasė <F>.

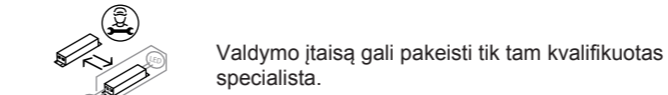

Valdymo įtaisą gali pakeisti tik tam kvalifikuotas specialistas.

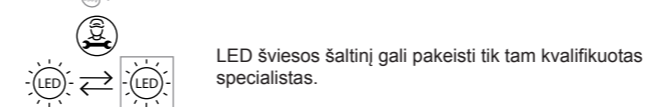

LED šviesos šaltinį gali pakeisti tik tam kvalifikuotas specialistas.

NL:
Lichtbron:
Dit product bevat een lichtbron van energie-efficiëntieklasse <F>.

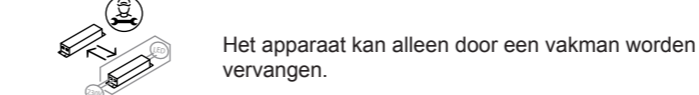

Het apparaat kan alleen door een vakman worden vervangen.

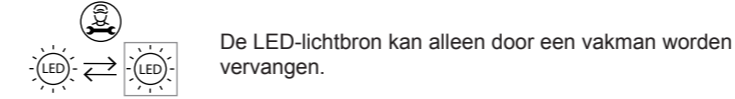

De LED-lichtbron kan alleen door een vakman worden vervangen.

Norwegisch/Norwegian / NO:
Dette produktet inneholder en lyskilde i energiklasse <F>.

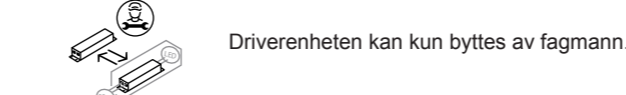

Driverenheten kan kun byttes av fagmann.

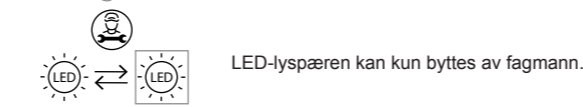

LED-lyspæren kan kun byttes av fagmann.

PL:
Źródło światła:
Ten produkt zawiera źródło światła o klasie efektywności energetycznej <F>.

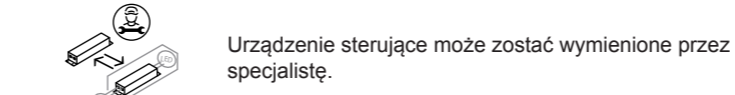

Urządzenie sterujące może zostać wymienione przez specjalistę.

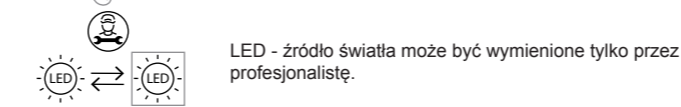

LED - źródło światła może być wymienione tylko przez profesjonalistę.

PT:
Fonte de Luz:
Este produto contém uma fonte de luz da classe de eficiência energética <F>.

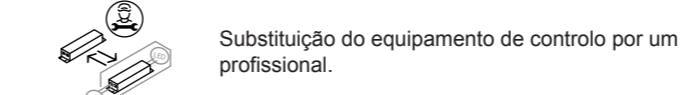

Substituição do equipamento de controlo por um profissional.

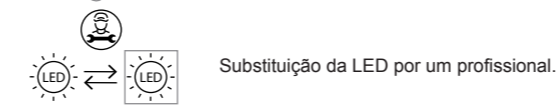

Substituição da LED por um profissional.

RO:
Sursa de lumina:
Acest produs conține o sursă de lumină cu clasa de eficiență energetică <F>.

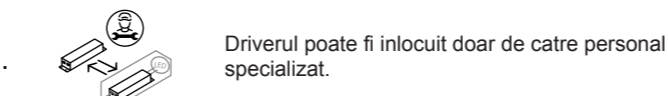

Driverul poate fi înlocuit doar de către personal specializat.

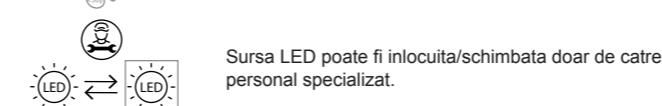

Sursa LED poate fi înlocuită/schimbata doar de către personal specializat.

RUS:
Источник света:
Данный продукт содержит источник света класса энергоэффективности <F>.

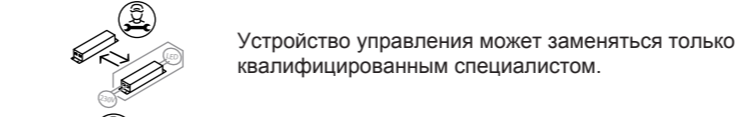

Устройство управления может заменяться только квалифицированным специалистом.

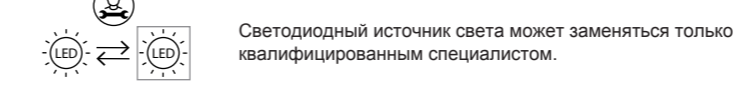

Светодиодный источник света может заменяться только квалифицированным специалистом.

SRB:
Izvor svetlosti:
Ovaj proizvod sadrži izvor svetlosti klase energetske efikasnosti <F>.

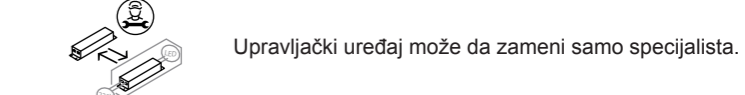

Upravljački uređaj može da zameni samo specijalista.



LED izvor svetlosti može da zameni samo specijalista.

SK:
Zdroj svetla:
Tento výrobok obsahuje svetelný zdroj triedy energetickej účinnosti <F>.

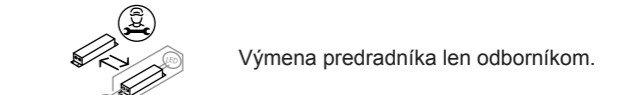

Výmena predradníka len odborníkom.

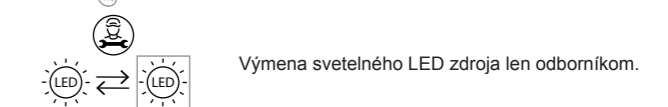

Výmena svetelného LED zdroja len odborníkom.

SI:
Izvor svetlobe:
Ta izdelek vsebuje svetlobni vir razreda energijske učinkovitosti <F>.

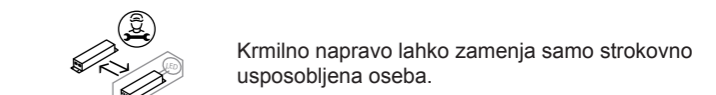

Krmilno napravo lahko zamenja samo strokovno usposobljena oseba.

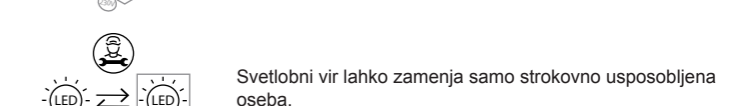

Svetlobni vir lahko zamenja samo strokovno usposobljena oseba.

ES:
Fuente de luz:
Este producto contiene una fuente luminosa de la clase de eficiencia energética <F>.

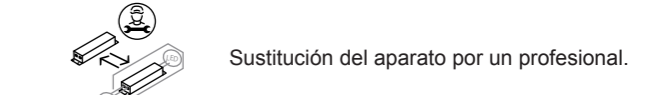

Sustitución del aparato por un profesional.

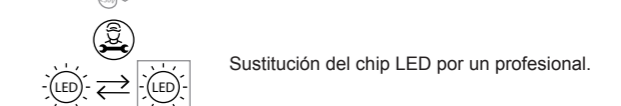

Sustitución del chip LED por un profesional.

SE:
Ljuskälla:
Denna produkt innehåller en ljuskälla med energieffektivitetsklass <F>.

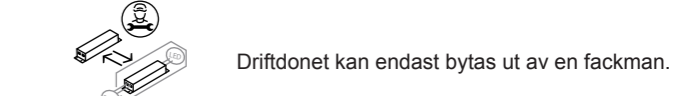

Driftdonet kan endast bytas ut av en fackman.

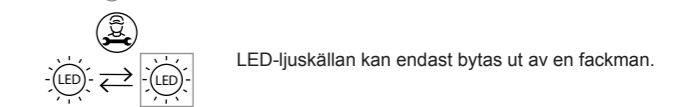

LED-ljuskällan kan endast bytas ut av en fackman.

TR:
Işık kaynağı:
Bu ürün, <F> enerji sınıfından bir ışık kaynağına sahiptir.

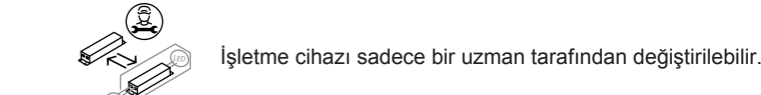

İşletme cihazı sadece bir uzman tarafından değiştirilebilir.

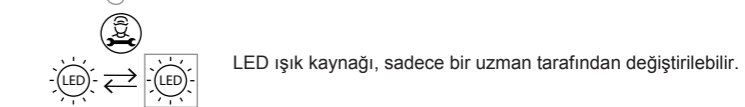

LED ışık kaynağı, sadece bir uzman tarafından değiştirilebilir.

UK:
Джерело світла:
Цей виріб містить джерело світла класу енергоефективності <F>.

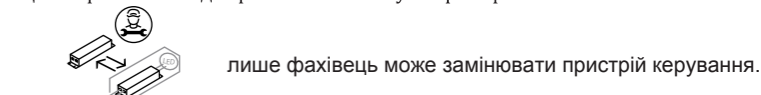

лише фахівець може замінювати пристрій керування.

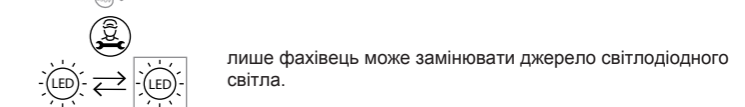

лише фахівець може замінювати джерело світлодіодного світла.