

# GLOBO

LIGHTING

WWW.globo-lighting.com  
34250

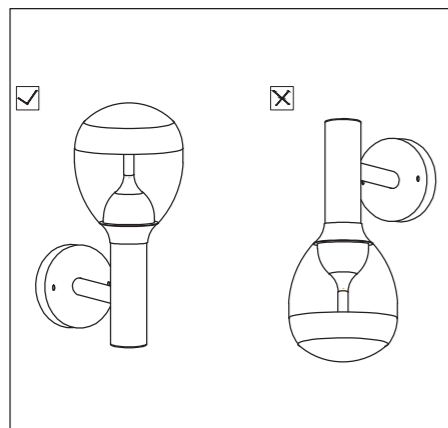
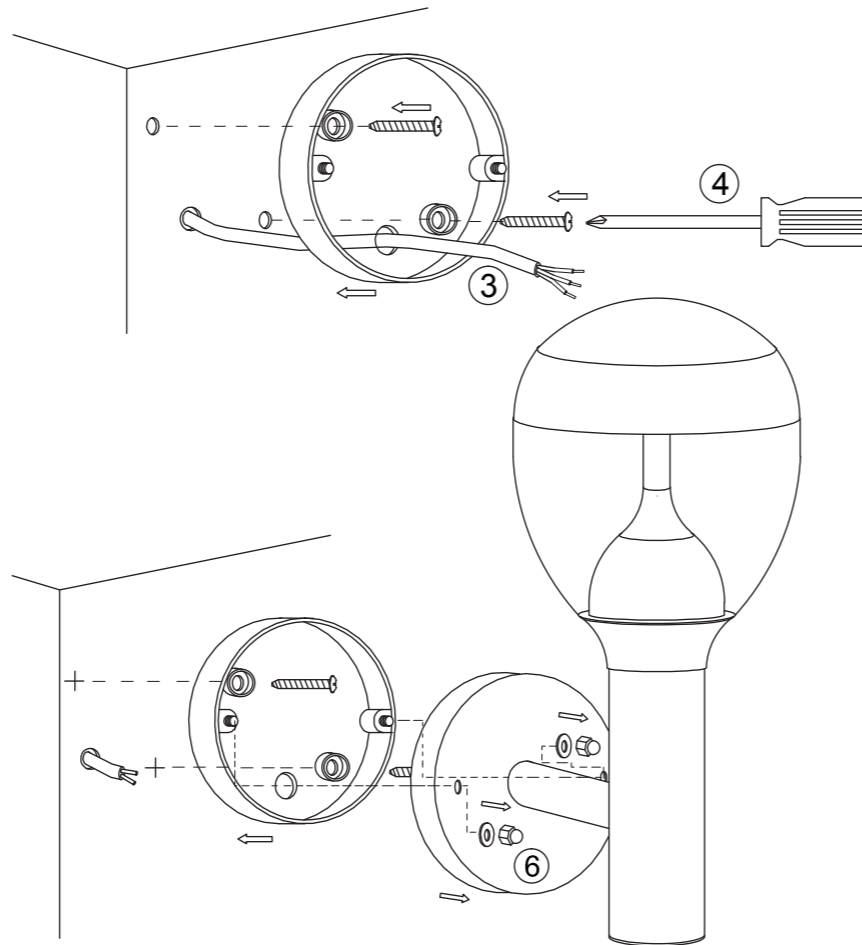
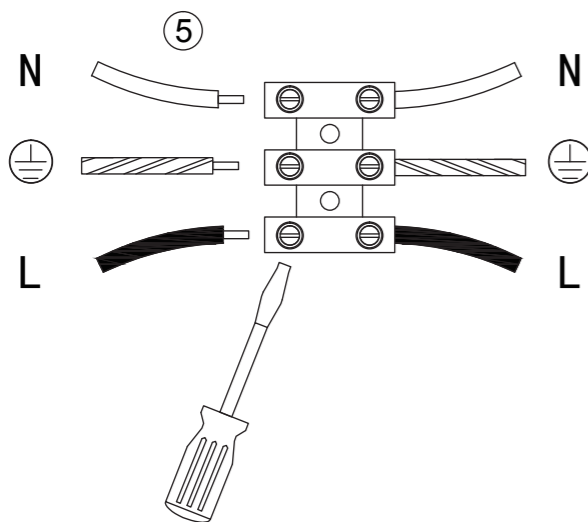
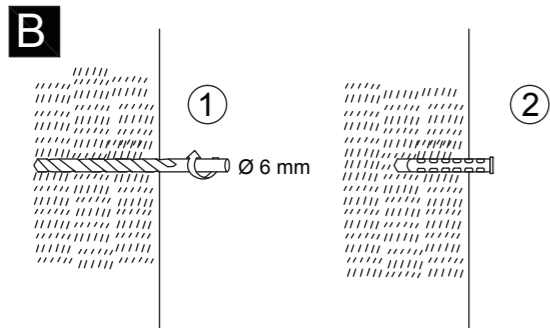
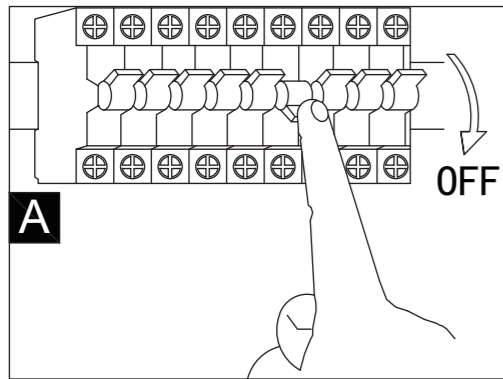

9W LED 45V  
220-240V~ 50/60Hz

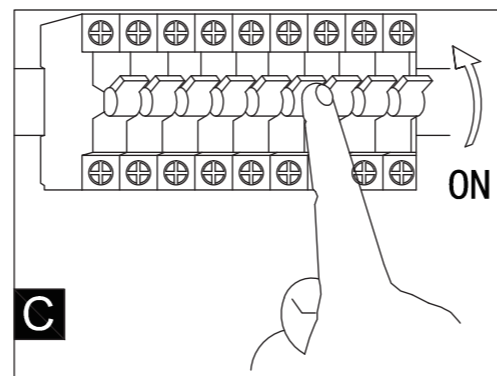

GLOBO Handels GmbH  
Gewerbestasse 3  
A-9184 Sankt Peter

## Lichtquelle / Light Source:

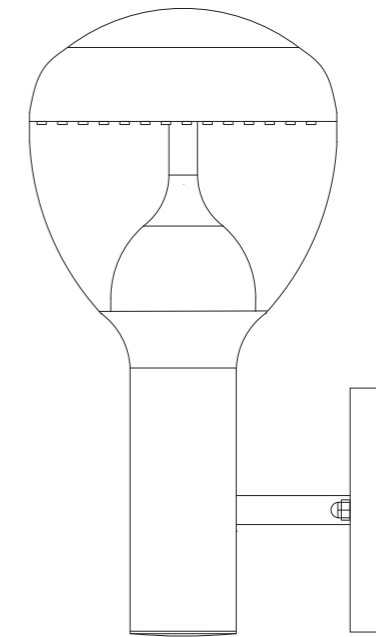

DEU:

Lichtquelle:

Die Lichtquelle ist nicht tauschbar, weil sie konstruktionsbedingt fest mit dem umgebenden Produkt verbunden ist. Dieses Produkt enthält eine Lichtquelle der Energieeffizienzklasse <E>.



Das Betriebsgerät ist nicht austauschbar.

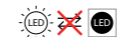

Die LED - Lichtquelle ist nicht austauschbar.

GBR:

Light source:

The light source is not interchangeable because it is determined by the surrounding product design. This product contains a light source of energy efficiency class <E>.



The control gear cannot be replaced.

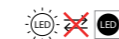

The LED - light source cannot be replaced

BIH & HR:

Izvor svjetla :

Izvor svjetla nije zamjenjiv , jer je konstrukcijski pričvršćen na proizvod . Ovaj proizvod sadržava izvor svjetlosti klase energetske učinkovitosti <E>.



LED – izvor svjetla nije moguće zamjeniti

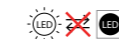

Pogonski uređaj se ne može zamjeniti

BG:

Източник на светлина:

Източникът на светлина не може да се подменя, тъй като поради конструкцията си е трайно фиксиран към заобикалящия го продукт.

Този продукт включва светлинен източник с клас на енергийна ефективност <E>.



Устройството за управление не може да се подменя.

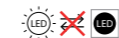

LED източникът на светлина не може да се подменя.

CZ:

Zdroj světla:

Světelný zdroj není možné vyměnit, protože je díky své konstrukci pevně spojený s produktem. Tento výrobek obsahuje světelný zdroj s třídou energetické účinnosti <E>.



Světelný zdroj není vyměnitelný.



Předřadník není vyměnitelný.

DK:

Lyskilde:

Lyskilden kan ikke udskiftes, fordi den er fast forbundet med det omgivende produkt. Dette produkt indeholder en lyskilde i energieffektivitetsklasse <E>.

 Driftsenheden kan ikke udskiftes.

  LED- lyskilden kan ikke udskiftes.

ET:

Valgusallikas:

Valgusallikas ei ole välja vahetatav, sest ta on tootega ehituslikult kindlalt seotud.

Toode sisaldab energiatõhususe klassi <E> valgusallikat.

 Juhtseadet ei saa asendada

  LED - valgusallikat ei saa asendada.

ES:

Fuente de luz:

La fuente de luz no es sustituible porque está fija en el producto desde la construcción. Este producto contiene una fuente luminosa de la clase de eficiencia energética <E>.

 Dispositivo de control no reemplazable.

  Bombilla no reemplazable.

FI:

Valonlähde:

Valonlähdettä ei voi vaihtaa uuteen, sillä se on rakenteellisesti yhdistetty ympäröivään tuotteeseen.

Tämä tuote sisältää valonlähteen, jonka energiatehokkuusluokka on <E>.

 Liitäntälaitetta ei voi vaihtaa uuteen.

  LED-valonlähdettä ei voi vaihtaa uuteen.

FR:

Source lumineuse:

La source lumineuse n'est pas remplaçable car elle est, de par la construction du produit, liée de façon permanente à celui-ci. Ce produit contient une source lumineuse de classe d'efficacité énergétique <E>.

 L'unité de contrôle n'est pas remplaçable

  La source lumineuse LED n'est pas remplaçable

GR:

Φωτεινή πηγή:

Η φωτεινή πηγή δεν μπορεί να αντικατασταθεί, επειδή είναι για κατασκευαστικούς λόγους σταθερά συνδεδεμένη με το προϊόν που την περιβάλλει.

Το προϊόν αυτό περιέχει φωτεινή πηγή της τάξης ενεργειακής απόδοσης <E>.

 Η λειτουργική συσκευή δεν αντικαθίσταται.

  Η φωτεινή πηγή LED δεν αντικαθίσταται

HU:

Fényforrás:

A fényforrás nem cserélhető, mert felépítése miatt szilárdan csatlakozik a termékhez. Ez a termék egy <E> energiahatékonysági osztályú fényforrást tartalmaz.

 Az előtét nem cserélhető.

  A fényforrás nem cserélhető



Isländisch/IS:

Ljósgjafi:

Ljósgjafinn er ekki útskiptanlegur vegna þess að hann er háður umliggjandi hönnun vörunnar.

Varan inniheldur ljósgjafa í orkuflokki <E>.

 Ekki er hægt að skipta um stjórnbúnaðinn.



  Ekki er hægt að skipta um LED-ljósgjafann

IT:

Sorgente luminosa:

La sorgente luminosa non è intercambiabile perché è saldamente collegata al prodotto per via del suo design. Questo prodotto contiene una sorgente luminosa di classe di efficienza energetica <E>.

 La centralina non può essere sostituita

  La sorgente luminosa a LED non può essere sostituita.



LV:

Gaismas avots:

Gaismas avotu nevar nomainīt, jo tas konstrukcijā ir cieši savienots ar izstrādājuma apkārtējo daļu.

Šis ražojums satur gaismas avotu, kura energoefektivitātes klase ir <E>.

 Vadības ierīci nevar nomainīt.

  LED apgaismes līdzekli nevar nomainīt.



LT:

Šviesos šaltinis:

Šis šviesos šaltinis yra nekeičiamas, nes jis prijungtas prie gaminio pagal jo konstrukciją.

Šiame gaminyje yra šviesos šaltinis, kurio energijos vartojimo efektyvumo klasė <E>.

 Valdymo įtaisas yra nekeičiamas.

  LED šviesos šaltinis yra nekeičiamas.



NL:

Lichtbron:

De lichtbron kan niet worden vervangen, omdat deze vanwege de constructie vast met het product eromheen verbonden is.

Dit product bevat een lichtbron van energie-efficiëntieklasse <E>.

 De LED-lichtbron kan niet worden vervangen.

  Het apparaat kan niet worden vervangen.



Norwegisch/Norwegian / NO:

Lyskilde:

Lyskilden kan ikke byttes fordi den sitter fast i produktet.

Dette produktet inneholder en lyskilde i energiklasse <E>.

 Driftsapparatet kan ikke byttes

  LED-lyspæren kan ikke byttes

PL:

Źródło światła:

Źródła światła nie można wymienić, ponieważ jest zintegrowane z produktem ze względu na swoją konstrukcję.

Ten produkt zawiera źródło światła o klasie efektywności energetycznej <E>.

 Nie można wymienić przekładni sterującej.

  LED - źródło światła nie może być wymienione.



PT:

Fonte de Luz:

A fonte de luz não é substituível porque devido às suas características construtivas está fixada de forma permanente ao produto circundante.

Este produto contém uma fonte de luz da classe de eficiência energética <E>.

 Equipamento de controlo não substituível.

  Lâmpada não substituível.

RO:

Sursa de lumina:

Sursa de lumina nu este inlocuibila ea fiind parte constructiva a produsului Acest produs conține o sursă de lumină cu clasa de eficiență energetică <E>.

 Driverul nu poate fi inlocuit



  Sursa de lumina nu poate fi inlocuita

RUS:

Источник света:

Источник света не является взаимозаменяемым, поскольку это определяется конструкцией смежного продукта. Данный продукт содержит источник света класса энергоэффективности <E>.

 Устройство управления не подлежит замене.

  Светодиодный источник света не подлежит замене.



SRB:

Izvor svetlosti:

Izvor svetlosti nije zamenljiv, jer je zbog svog dizajna čvrsto povezan sa proizvodom koji ga opkružuje.

Ovaj proizvod sadrži izvor svetlosti klase energetske efikasnosti <E>.

 Upravljački uređaj nije zamenljiv.

  LED izvor svetlosti nije zamenljiv.



SK:

Zdroj svetla:

Svetelný zdroj nie je možné vymeniť, pretože je vďaka svojej konštrukcii pevne spojený s produktom.

Tento výrobok obsahuje svetelný zdroj triedy energetickej účinnosti <E>.

 Predradník nie je vymeniteľný.

  LED izvor svetlosti nije zamenljiv

SI:

Izvor svetlobe:

Vir svetlobe ni zamenljiv, ker je določen z zasnovno izdelka v okolici.

Ta izdelek vsebuje svetlobni vir razreda enerjske učinkovitosti <E>.

 Krmilnik ni mogoče zamenjati.

  Svetlobni vir ni mogoče zamenjati.



SE:

Ljuskälla:

Ljuskällan är inte utbytbar, eftersom den på grund av konstruktionen är fast integrerad i den omgivande produkten.

Denna produkt innehåller en ljuskälla med energieffektivitetsklass <E>.

 Driftdonet kan inte bytas ut.

  LED-ljuskällan kan inte bytas ut.



TR:

Işık kaynağı:

Konstrüksiyon gereği çevreleyen ürün ile sabit bir şekilde bağlı olduğu için ışık kaynağı değiştirilemez.

Bu ürün, <E>enerji sınıfından bir ışık kaynağına sahiptir.

 İşletme cihazı değiştirilemez.

  LED ışık kaynağı değiştirilemez.

UK:

Джерелосвітла:

Джерелосвітланеможнообміняти, оскількивномоцічнопов'язанезнавколишнімвиробомзавдякисвоїйконструкції.

Цей виріб містить джерело світла класу енергоефективності <E>.

 – пристрій керування не можна замінювати.

  – джерело світлодіодного світла не можна замінювати.