

GLOBO

LIGHTING
36507

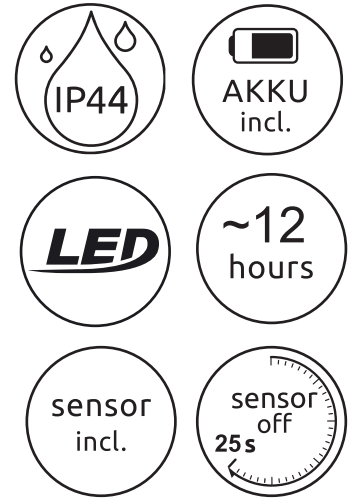

- ⏻ 1. Long press 3sec.: ON
 2. Short press: Change sensor mode ① & ② & ③
 3. Long press 3sec.: OFF

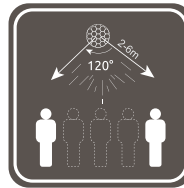
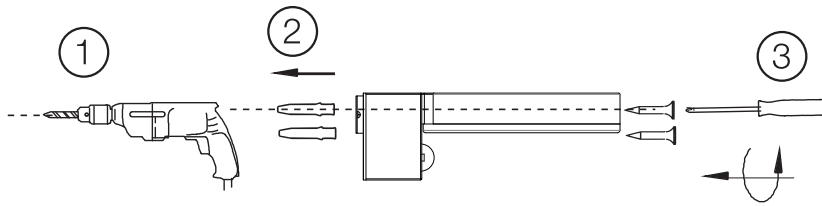
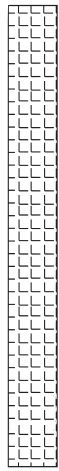
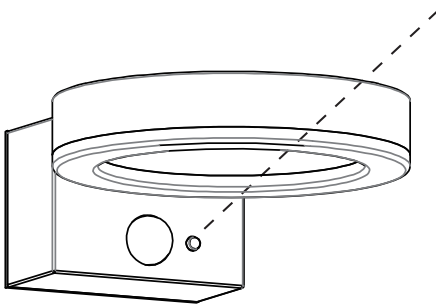

1x 6W LED DC 3,7V
 1x 2200mAh 3,7V Li-ion battery

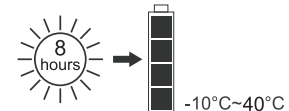
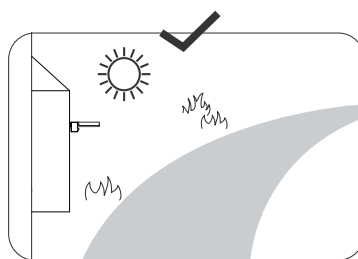
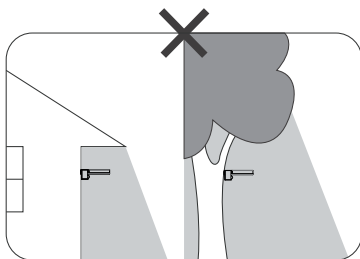
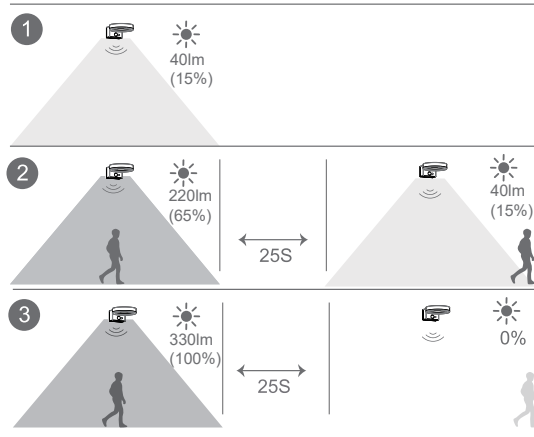

GLOBO Handels GmbH
 Gewerbestr. 3 A-9184 Sankt Peter, Austria
www.globo-lighting.com
office@globo-lighting.com

AKKU DATA
 18650 Li-ion RECHARGEABLE

*Manufacturer: Shandong Anodepower Battery Co., Ltd
 Address: Yanggu Double Innovation Industrial Park, East Industrial Concentration Zone, Yanggu County Economic Development Zone, Liaocheng City, Shandong Province
 Model: ZNL 18650 2200mAh 3.7V 8.14Wh

SAFETY INSTRUCTIONS