

# GLOBO

## LIGHTING

41314-40

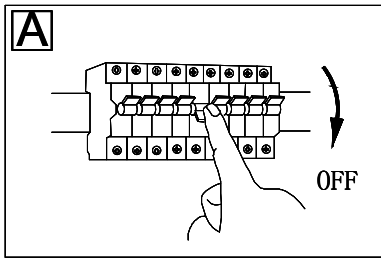

**B**

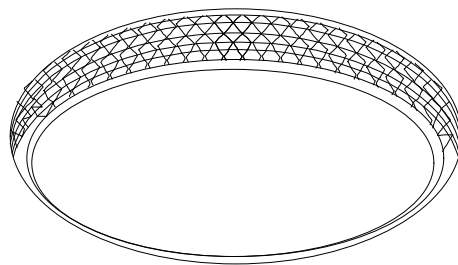
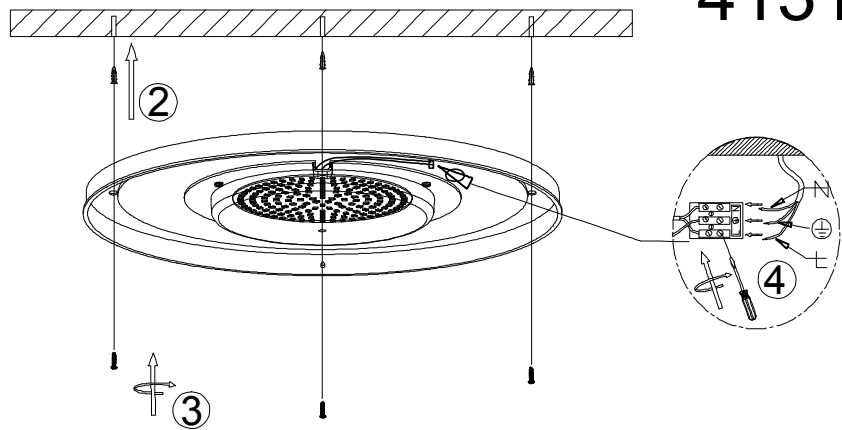

incl.



many light steps



dimnable



3 LIGHT STEPS  
4000 K 6500 K  
3000 K



colour fixing



many steps



night light



3000 K - 6500 K

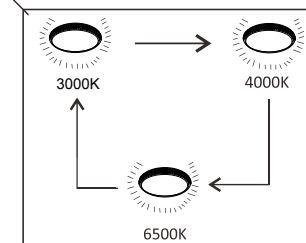
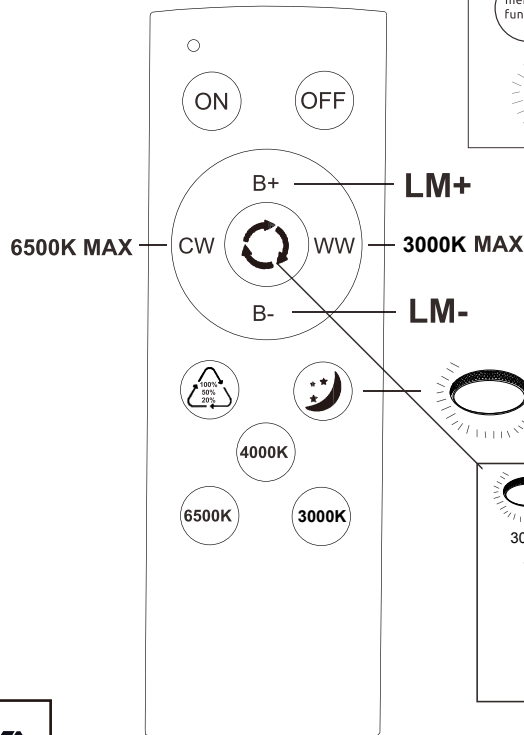
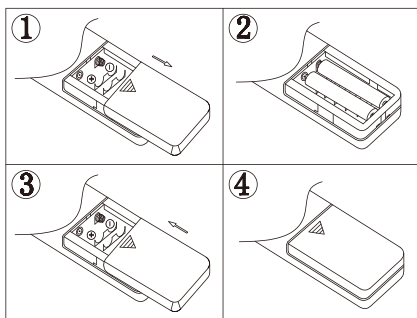
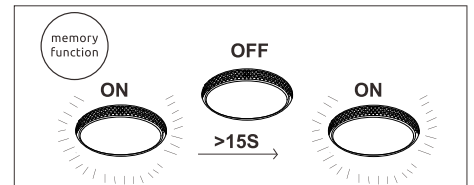

**BATTERY DATA**

2x AAA battery\* incl.  
\*Manufacturer: Ningbo GP & Sonlux Battery Co., Ltd  
Address: No.600 Qingfeng Road, Cicheng Town  
Jiangbei District, Ningbo, Zhejiang, China  
Model: R03, 1.5V



**SAFETY INSTRUCTIONS**



1x MAX 40W LED  
220-240V~ 50/60Hz

GLOBO Handels GmbH  
Gewerbestr. 3  
A-9184 Sankt Peter, Austria  
[www.globo-lighting.com](http://www.globo-lighting.com)  
[office@globo-lighting.com](mailto:office@globo-lighting.com)

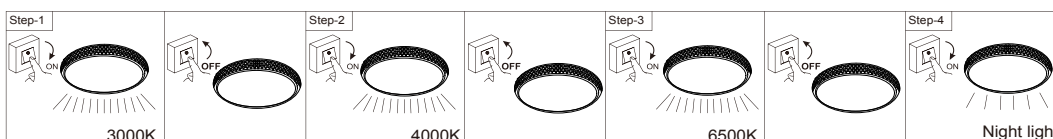
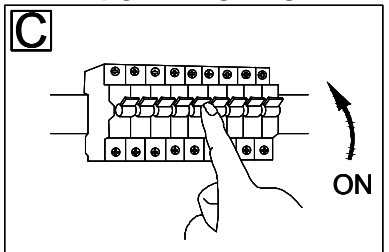

# Lichtquelle:

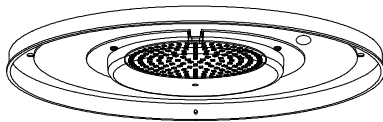

## DEU:

### Lichtquelle:



Die Lichtquelle ist nicht tauschbar, weil sie konstruktionsbedingt fest mit dem umgebenden Produkt verbunden ist.  
Dieses Produkt enthält eine Lichtquelle der Energieeffizienzklasse <E>.

  Die LED - Lichtquelle ist nicht austauschbar.

## BG:

### Източник на светлина:

Източникът на светлина не може да се подменя, тъй като поради конструкцията си е трайно фиксиран към заобикалящия го продукт.  
Този продукт включва светлинен източник с клас на енергийна ефективност <E>.

  LED източникът на светлина не може да се подменя.

## BIH:

### Izvor svjetla :



Izvor svjetla nije zamjenjiv , jer je konstrukcijski pričvršćen na proizvod.  
Ovaj proizvod sadržava izvor svjetlosti klase energetske učinkovitosti <E>.

  LED – izvor svjetla nije moguće zamjeniti

## CZ:

### Zdroj světla:

Světelný zdroj není možné vyměnit, protože je díky své konstrukci pevně spojený s produktem.  
Tento výrobek obsahuje světelný zdroj s třídou energetické účinnosti <E>.

  Světelný zdroj není vyměnitelný.

## DK:

### Lyskilde:

Lyskilden kan ikke udskiftes, fordi den er fast forbundet med det omgivende produkt.  
Dette produkt indeholder en lyskilde i energieffektivitetsklasse <E >.

  LED- lyskilden kan ikke udskiftes.

## ES:

### Fuente de luz:



La fuente de luz no es sustituible porque está fija en el producto desde la construcción.  
Este producto contiene una fuente luminosa de la clase de eficiencia energética <E>.

  Bombilla no reemplazable.

## ET:

### Valgusallikas:

Valgusallikas ei ole välja vahetatav, sest ta on tootega ehituslikult kindlalt seotud.  
Toode sisaldab energiatõhususe klassi <E> valgusallikat.

  LED - valgusallikat ei saa asendada.

## FI:

### Valonlähde:

Valonlähdettä ei voi vaihtaa uuteen, sillä se on rakenteellisesti yhdistetty ympäröivään tuotteeseen.  
Tämä tuote sisältää valonlähteen, jonka energiatehokkuusluokka on <E>.

  LED-valonlähdettä ei voi vaihtaa uuteen.

## FR:

### Source lumineuse:



La source lumineuse n'est pas remplaçable car elle est, de par la construction du produit, liée de façon permanente à celui-ci.  
Ce produit contient une source lumineuse de classe d'efficacité énergétique <E>.

  La source lumineuse LED n'est pas remplaçable.

## SRB:

### Izvor svetlosti:



Izvor svetlosti nije zamenljiv, jer je zbog svog dizajna čvrsto povezan sa proizvodom koji ga opkružuje.  
Ovaj proizvod sadrži izvor svetlosti klase energetske efikasnosti <E>.

  LED izvor svetlosti nije zamenljiv.

## SE:

### Ljuskälla:



Ljuskällan är inte utbytbar, eftersom den på grund av konstruktionen är fast integrerad i den omgivande produkten.  
Denna produkt innehåller en ljuskälla med energieffektivitetsklass <E>.

  LED-ljuskällan kan inte bytas ut.

## TR:

### Işık kaynağı:

Konstrüksiyon gereği çevreleyen ürün ile sabit bir şekilde bağlı olduğu için ışık kaynağı değiştirilemez.  
Bu ürün, <E> enerji sınıfından bir ışık kaynağına sahiptir.



  LED ışık kaynağı değiştirilemez.

## GBR:

### Light source:

The light source is not interchangeable because it is determined by the surrounding product design.

This product contains a light source of energy efficiency class <E>.

  The LED - light source cannot be replaced.

## HR:

### Izvor svjetla :

Izvor svjetla nije zamjenjiv , jer je konstrukcijski pričvršćen na proizvod .  
Ovaj proizvod sadržava izvor svjetlosti klase energetske učinkovitosti <E>.

  LED – izvor svjetla nije moguće zamjeniti

## HU:

### Fényforrás:



A fényforrás nem cserélhető, mert felépítése miatt szilárdan csatlakozik a termékhez.  
Ez a termék egy <E> energiahatékonysági osztályú fényforrást tartalmaz.

  A fényforrás nem cserélhető

## IT:

### Sorgente luminosa:

La sorgente luminosa non è intercambiabile perché è saldamente collegata al prodotto per via del suo design.  
Questo prodotto contiene una sorgente luminosa di classe di efficienza energetica <E>.

  La sorgente luminosa a LED non può essere sostituita.

## SI:

### Izvor svetlobe:



Vir svetlobe ni zamenljiv, ker je določen z zasnovno izdelka v okolici.  
Ta izdelek vsebuje svetlobni vir razreda enerjske učinkovitosti <E>.

  Svetlobni vir ni mogoče zamenjati.

## LT:

### Šviesos šaltinis:

Šis šviesos šaltinis yra nekeičiamas, nes jis prijungtas prie gaminio pagal jo konstrukciją.  
Šiame gaminyje yra šviesos šaltinis, kurio energijos vartojimo efektyvumo klasė <E>.

  LED šviesos šaltinis yra nekeičiamas.

## LV:

### Gaismas avots:

Gaismas avotu nevar nomainīt, jo tas konstrukcijā ir cieši savienots ar izstrādājuma apkārtējo daļu.

Šis ražojums satur gaismas avotu, kura energoefektivitātes klase ir <E>.



  LED apgaismes līdzekli nevar nomainīt.

## NL:

### Lichtbron:

De lichtbron kan niet worden vervangen, omdat deze vanwege de constructie vast met het product eromheen verbonden is.

Dit product bevat een lichtbron van energie-efficiëntieklasse <E>.

  De LED-lichtbron kan niet worden vervangen.

## NO:

### Lyskilde:

Lyskilden kan ikke byttes fordi den sitter fast i produktet.  
Dette produktet inneholder en lyskilde i energiklasse <E>.

  LED-lyspæren kan ikke byttes.

## RUS:

### Источник света:

Источник света не является взаимозаменяемым, поскольку это определяется конструкцией смежного продукта.

Данный продукт содержит источник света класса энергоэффективности <E>.



  Светодиодный источник света не подлежит замене.

## SK:

### Zdroj svetla:

Svetelný zdroj nie je možné vymeniť, pretože je vďaka svojej konštrukcii pevné spojený s produktom.



Tento výrobok obsahuje svetelný zdroj triedy energetickej účinnosti <E>.

  Svetelný zdroj nie je vymeniteľný.

## SI:

### Izvor svetlobe:

Vir svetlobe ni zamenljiv, ker je določen z zasnovno izdelka v okolici.  
Ta izdelek vsebuje svetlobni vir razreda enerjske učinkovitosti <E>.

  Svetlobni vir ni mogoče zamenjati.