

GLOBO

LIGHTING

www.globo-lighting.com

41367-40

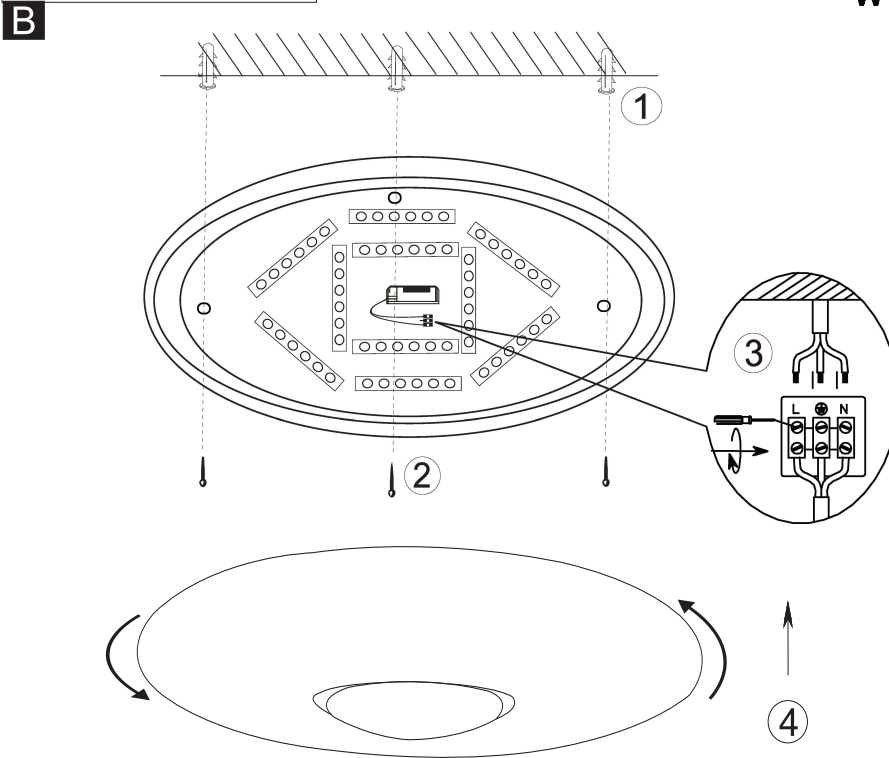
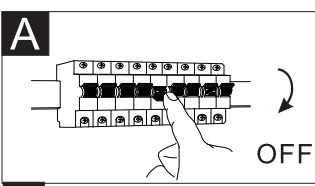

- incl.
- 70-1500lm output
- dimmable
- colour fixing
- RGB colour change
- RGB colour fixing
- 4000 K 3 light steps 3000 K 6500 K
- many light steps
- colour change
- 3000 K - 6500 K
- night light
- memory function
- rainbow effect

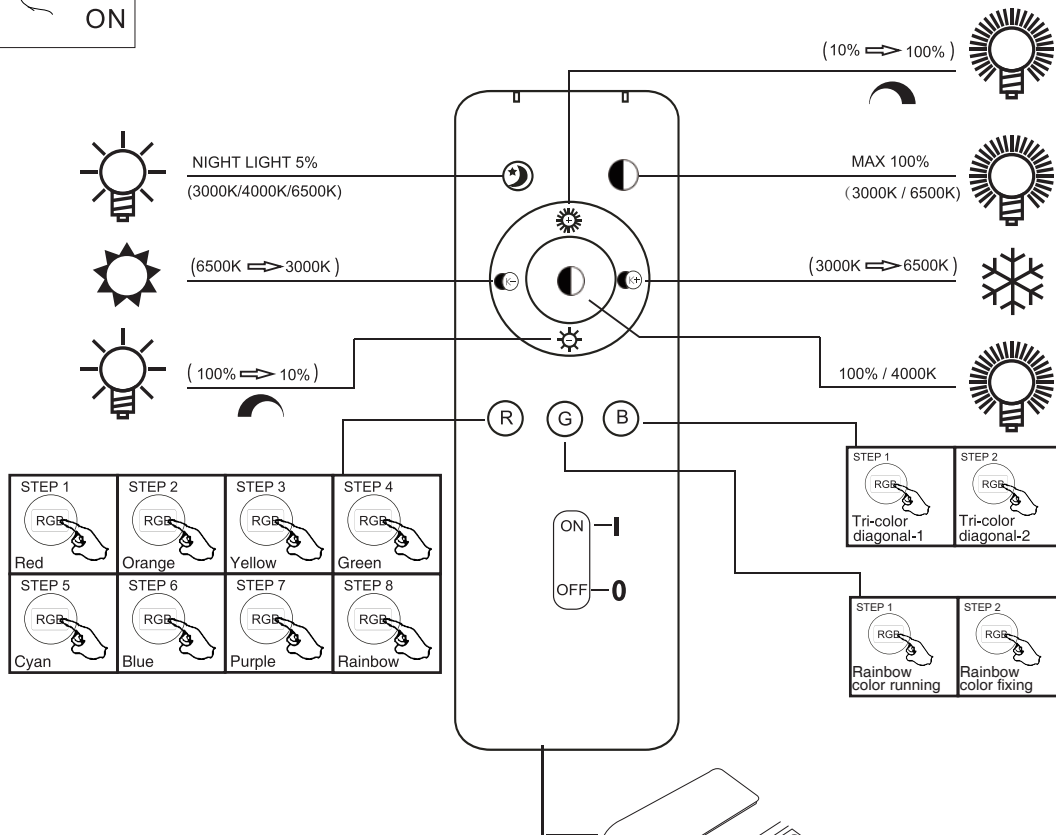
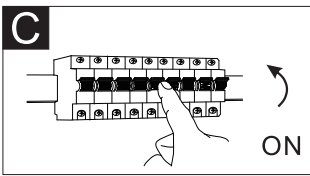

STEP 1 Red	STEP 2 Orange	STEP 3 Yellow	STEP 4 Green
STEP 5 Cyan	STEP 6 Blue	STEP 7 Purple	STEP 8 Rainbow

STEP 1 Tri-color diagonal-1	STEP 2 Tri-color diagonal-2
STEP 1 Rainbow color running	STEP 2 Rainbow color fixing

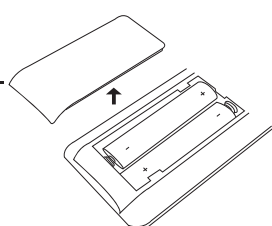

Battery: 2 * AAA (incl.)

GLOBO Handels GmbH
Gewerbestr. 3
A-9184 Sankt Peter
Austria

DEU:
Lichtquelle
Die Lichtquelle ist nicht tauschbar, weil sie konstruktionsbedingt fest mit dem umgebenden Produkt verbunden ist.
Dieses Produkt enthält eine Lichtquelle der Energieeffizienzklasse <F>.

 Austausch des Betriebsgeräts durch einen Professionisten.   Leuchtmittel nicht austauschbar.



GBR:
Light source:
The light source is not interchangeable because it is determined by the surrounding product design.
This product contains a light source of energy efficiency class <F>.

 Replaceable control gear by a professional.   Non replaceable light source.



BIH:
Izvor svjetla :
Izvor svjetla nije zamjenjiv , jer je konstrukcijski pričvršćen na proizvod .
Ovaj proizvod sadržiava izvor svjetlosti klase energetske učinkovitosti <F>.

 Izmjenu pogonskog uređaja smije izvršiti i samo profesionalna osoba.   LED žarulje nije moguće zamjenit.



BG:
Източник на светлина:
Източникът на светлина не може да се подменя, тъй като поради конструкцията си е трайно фиксиран към заобикалящия го продукт.
Този продукт включва светлинен източник с клас на енергийна ефективност <F>.

 Смяна на управляващото устройство от професионалист.   Източникът на светлина не може да се подменя.



CZ:
Zdroj světla:
Světelný zdroj není možné vyměnit, protože je díky své konstrukci pevně spojený s produktem. Tento výrobek obsahuje světelný zdroj s třídou energetické účinnosti <F>.

 Výměna předřadníku jen odborníkem.   Světelný zdroj není vyměnitelný.



DK:
Lyskilde:
Lyskilden kan ikke udskiftes, fordi den er fast forbundet med det omgivende produkt.
Dette produkt indeholder en lyskilde i energieffektivitetsklasse <F>.

 Enheden skal skiftes af en fagperson.   Lyskilden kan ikke udskiftes.

ET:
Valgusallikas:
Valgusallikas ei ole välja vahetatav, sest ta on tootega hituslikult kindlat seotud.
Toode sisaldab energiatõhususe klassi <F> valgusallikat.

 Juhtimiseseadise välja vahetamine professionaali poolt.   Lamp ei ole välja vahetatav.



FI:
Valonlähde:
Valonlähdeettä ei voi vaihtaa uuteen, sillä se on rakenteellisesti yhdistetty ympäröivään tuotteeseen.
Tämä tuote sisältää valonlähteen, jonka energiatehokkuusluokka on <F>.

 Liitäntälaitteen vaihtaa ammattilainen.   Valonlähdeettä ei voi vaihtaa.



FR:
Source lumineuse:
La source lumineuse n'est pas remplaçable car elle est, de par la construction du produit, liée de façon permanente à celui-ci.
Ce produit contient une source lumineuse de classe d'efficacité énergétique <F>.

 Remplacement du dispositif de commande par un professionnel.   Ampoule non remplaçable.



GR:
Φωτεινή πηγή:
Η φωτεινή πηγή δεν μπορεί να αντικατασταθεί, επειδή είναι για κατασκευαστικούς λόγους σταθερά συνδεδεμένη με το προϊόν που την περιβάλλει.
Το προϊόν αυτό περιέχει φωτεινή πηγή της τάξης ενεργειακής απόδοσης <F>.

 Αντικατάσταση της διάταξης λειτουργίας από έναν επαγγελματία.   Ο λαμπτήρας δεν μπορεί να αντικατασταθεί.

HU:
Fényforrás:
A fényforrás nem cserélhető, mert felépítése miatt szilárdan csatlakozik a termékhez Ez a termék egy <F> energiatékonysági osztályú fényforrást tartalmaz.

 Az előléttét csak szakértők cserélhetik ki.   A fényforrás nem cserélhető.

Isländisch/IS:
Ljósgrafi:
Ljósgrafinn er ekki útskiptanlegur vegna þess að hann er háður umliggjandi hönnun vörunnar.
Varan inniheldur ljósgrafa í orkuflökki <F>.

 Útskiptanlegur stýribúnaður sem fagmaður á að framkvæma.   Ekki útskiptanlegur ljósgrafi.

IT:
Sorgente luminosa:
La sorgente luminosa non è intercambiabile perché è saldamente collegata al prodotto per via del suo design.
Questo prodotto contiene una sorgente luminosa di classe di efficienza energetica <F>.

 Izmjenu pogonskog uređaja smije izvršiti i samo profesionalna osoba.   LED žarulje nije moguće zamjenit.

HR :
Izvor svjetla :
Izvor svjetla nije zamjenjiv , jer je konstrukcijski pričvršćen na proizvod .
Ovaj proizvod sadržiava izvor svjetlosti klase energetske učinkovitosti <F>.

 Izmjenu pogonskog uređaja smije izvršiti i samo profesionalna osoba.   LED žarulje nije moguće zamjeniti.

LV:
Gaismas avots:
Gaismas avotu nevar nomainīt, jo tas konstrukcijā ir cieši savienots ar izstrādājuma apkārtējo daļu.
Šis ražojums satur gaismas avotu, kura energoefektivitātes klase ir <F>.

 Vadības ierīci var nomainīt speciālists.   Apgaismes līdzekļi nevar nomainīt.

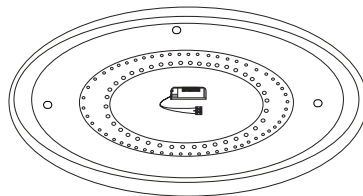

LT:
Šviesos šaltinis:
Šis šviesos šaltinis yra nekeičiamas, nes jis prijungtas prie gaminio pagal jo konstrukciją.
Šiame gaminyje yra šviesos šaltinis, kurio energijos vartojimo efektyvumo klasė <F>.

 Valdymo įtaisą keičia profesionalas.   Šviesos šaltinis yra nekeičiamas.



NL:
Lichtbron:
De lichtbron kan niet worden vervangen, omdat deze vanwege de constructie vast met het product eromheen verbonden is.
Dit product bevat een lichtbron van energie-efficiëntieklasse <F>.

 Vervanging van het apparaat door een expert.   Verlichting kan niet worden vervangen.



Norwegian/Norwegian / NO:
Lyskilde:
Lyskilden kan ikke byttes fordi den sitter fast i produktet.
Dette produktet inneholder en lyskilde i energiklasse <F>.

 Byte av driftsapparatet må gjøres av fagmann.   Lyskilden kan ikke byttes ut.



PL:
Źródło światła:
Źródła światła nie można wymienić, ponieważ jest zintegrowane z produktem ze względu na swoją konstrukcję.
Ten produkt zawiera źródło światła o klasie efektywności energetycznej <F>.

 Wymiana osprzętu sterującego wyłącznie przez specjalistę.   Źródła światła nie można wymienić.



PT:
Fonte de Luz:
A fonte de luz não é substituível porque devido às suas características construtivas está fixada de forma permanente ao produto circundante.
Este produto contém uma fonte de luz da classe de eficiência energética <F>.

 Substituição do dispositivo de comando por parte de um profissional.   Lâmpada não substituível.



RO:
Sursa de lumina:
Sursa de lumina nu este inlocuibilă ea fiind parte constructivă a produsului
Acest produs conține o sursă de lumină cu clasa de eficiență energetică <F>.

 Schimbarea unitatii de control trebuie facuta doar de catre personal.   Sursa de lumina nu poate fi schimbata.

RUS:
Источник света:
Источник света не является взаимозаменяемым, поскольку это определяется конструкцией смежного продукта.
Данный продукт содержит источник света класса энергоэффективности <F>.

 Замена регулировочного механизма специалистом.   Незаменяемый источник света.



SRB:
Izvor svetlosti:
Izvor svetlosti nije zamenljiv, jer je zbog svog dizajna čvrsto povezan sa proizvodom koji ga okružuje. Ovaj proizvod sadrži izvor svetlosti klase energetske efikasnosti <F>.

 Zamena upravljačkog uređaja od strane profesionalca.   Izvor svetlosti se ne može zameniti.

SK:
Zdroj svetla:
Svetelný zdroj nie je možné vymeniť, pretože je vďaka svojej konštrukcii pevne spojený s produktom. Tento výrobok obsahuje svetelný zdroj triedy energetickej účinnosti <F>.

 Výmena predradníka len odborníkom.   Svetelný zdroj nie je vymeniteľný.



SI:
Izvor svetlobe:
Vir svetlobe ni zamenljiv, ker je določen z zasnovno izdelka v okolici.
Ta izdelek vsebuje svetlobni vir razreda energijske učinkovitosti <F>.

 Zamenljiv krmilnik s strani strokovne osebe.   Nezamenljiv vir svetlobe.



ES:
Fuente de luz:
La fuente de luz no es sustituible porque está fija en el producto desde la construcción.
Este producto contiene una fuente luminosa de la clase de eficiencia energética <F>.

 Sustitución del aparato por un profesional.   Bombilla no reemplazable.



SE:
Ljuskälla:
Ljuskällan är inte utbyttbar, eftersom den på grund av konstruktionen är fast integrerad i den omgivande produkten.
Denna produkt innehåller en ljuskälla med energieffektivitetsklass <F>.

 Byte av driftdonet genom en fackman.   Ljuskällan är inte utbyttbar.

TR:
Işık kaynağı:
Konstrüksiyon gereği çevreleyen ürünü ile sabit bir şekilde bağlı olduğu için ışık kaynağı değiştirilemez.
Bu ürün, <F> enerji sınıfından bir ışık kaynağına sahiptir.

 İşletme cihazının bir profesyonel tarafından değiştirilmesi.   Aydınlatma malzemesi değiştirilemez.

UK:
Джерело світла:
Джерело світла не можна обміняти, оскільки воно міцно пов'язане з навколишнім виробом завдяки своїй конструкції.
Цей виріб містить джерело світла класу енергоефективності <F>.

 Заміна контрольної передачі професіоналом.   Цібулини не взаємозамінні.