

GLOBO LIGHTING

A

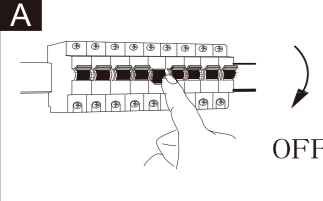

B

41563-18W/18B/18WW/18MM MAX 18W LED DC 170V, 220V-240V 50/60Hz
41563-24W/24B/24WW/24MM MAX 24W LED DC 130V, 220V-240V 50/60Hz

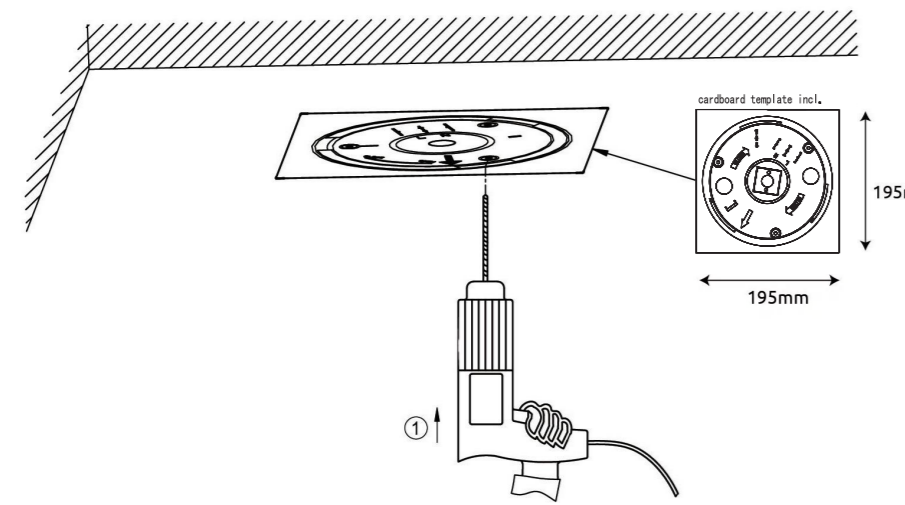

cardboard template incl. 195mm

195mm

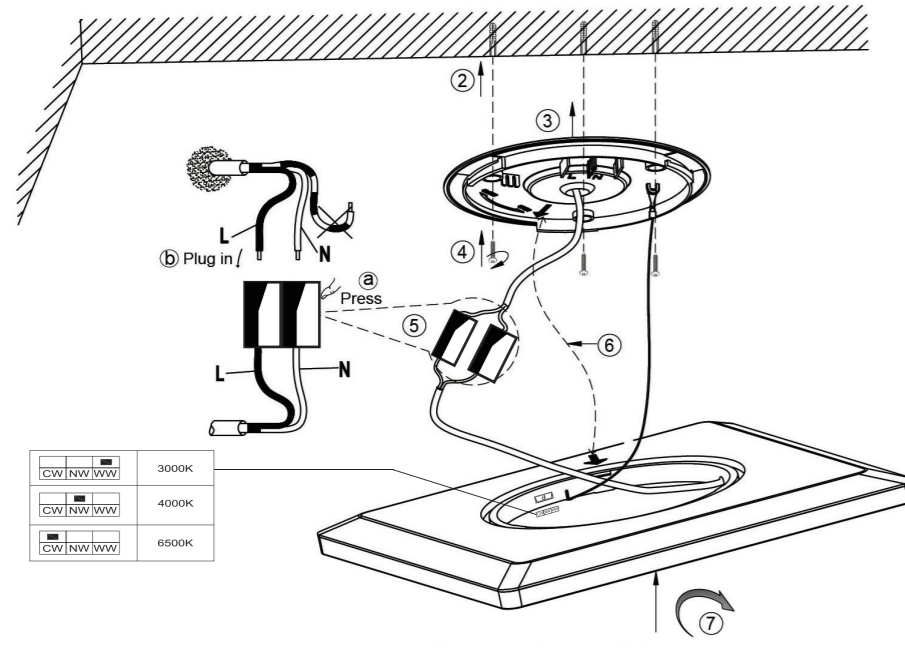

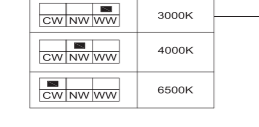



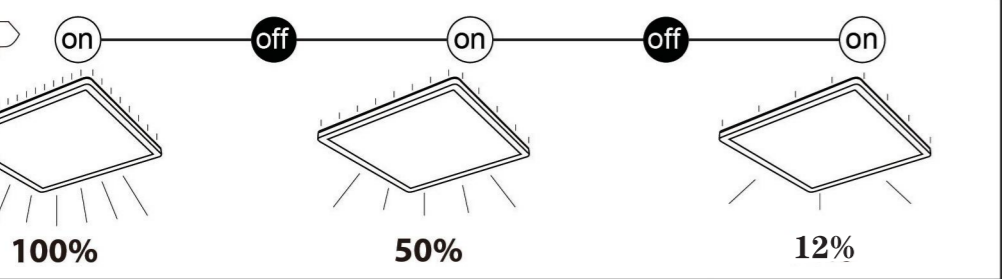



3000K	4000K	6500K
3 light steps 3000K		

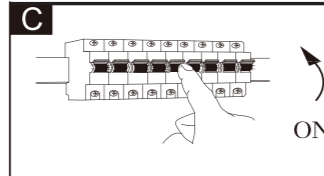

100%	50%	12%
------	-----	-----

C





-  3-step memory function
-  IP44
-  back light
-  memory function
-  many steps

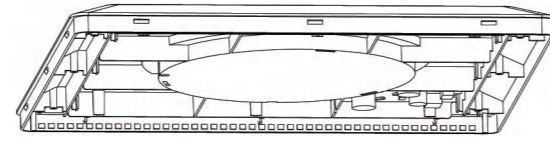

GLOBO Handels GmbH
Gewerbstrasse 3
A-9184 Sankt Peter, AUSTRIA
office@globo-lighting.com | www.globo-lighting.com

Lichtquelle/Light source:





DEU:
Lichtquelle:
Die Lichtquelle ist nicht tauschbar, weil sie konstruktionsbedingt fest mit dem umgebenden Produkt verbunden ist.
Dieses Produkt enthält eine Lichtquelle der Energieeffizienzklasse <E>.

  Die LED - Lichtquelle ist nicht austauschbar.



  Das Betriebsgerät ist nicht austauschbar.



GBR:
Light source:
The light source is not interchangeable because it is determined by the surrounding product design.
This product contains a light source of energy efficiency class <E>.

  The LED - light source cannot be replaced.



  The control gear cannot be replaced.

BIH&HR:
Izvor svjetla:
Izvor svjetla nije zamjenjiv, jer je konstrukcijski pričvršćen na proizvod. Ovaj proizvod sadržava izvor svjetlosti klase energetske učinkovitosti <E>.

  LED – izvor svjetla nije moguće zamjeniti

  Pogonski uređaj se ne može zamjeniti.

BG:
Източник на светлина:
Източникът на светлина не може да се подменя, тъй като поради конструкцията си е трайно фиксиран към заобикаляния го продукт. Този продукт включва светлинен източник с клас на енергийна ефективност <E>.

  LED източникът на светлина не може да се подменя.

  Устройството за управление не може да се



CZ:
Zdroj světla:
Světelný zdroj není možné vyměnit, protože je díky své konstrukci pevně spojený s produktem.
Tento výrobek obsahuje světelný zdroj s třídou energetické účinnosti <E>.

  Světelný zdroj není vyměnitelný.

  Předradník není vyměnitelný.



DK:
Lyskilde:
Lyskilden kan ikke udskiftes, fordi den er fast forbundet med det omgivende produkt.
Dette produkt indeholder en lyskilde i energieffektivitetsklasse <E>.

  LED- lyskilden kan ikke udskiftes.

  Driftsenheden kan ikke udskiftes.



ET:
Valgusallikas:
Valgusallikas ei ole välja vahetatav, sest ta on tootega ehituslikult kindlalt seotud.
Toode sisaldab energiatõhususe klassi <E> valgusallikat.



  LED - valgusallikat ei saa asendada.

  Juhtseadet ei saa asendada.

FI:

Valonlähde:
Valonlähettä ei voi vaihtaa uuteen, sillä se on rakenteellisesti yhdistetty ympäröivään tuotteeseen.
Tämä tuote sisältää valonlähteen, jonka energiatehokkuusluokka on <E>.

  LED-valonlähettä ei voi vaihtaa uuteen.

  Liitäntälaitetta ei voi vaihtaa uuteen.

FR:
Source lumineuse:
La source lumineuse n'est pas remplaçable car elle est, de par la construction du produit, liée de façon permanente à celui-ci.
Ce produit contient une source lumineuse de classe d'efficacité énergétique <E>.

  La source lumineuse LED n'est pas remplaçable.

  L'unité de contrôle n'est pas remplaçable.



GR:
Φωτεινή πηγή:
Η φωτεινή πηγή δεν μπορεί να αντικατασταθεί, επειδή είναι για κατασκευαστικούς λόγους σταθερά συνδεδεμένη με το προϊόν που την περιβάλλει.
Το προϊόν αυτό περιέχει φωτεινή πηγή της τάξης ενεργειακής απόδοσης <E>.

  Η φωτεινή πηγή LED δεν αντικαθίσταται.

  Η λειτουργική συσκευή δεν αντικαθίσταται.



HU:
Fényforrás:
A fényforrás nem cserélhető, mert felépítése miatt szilárdan csatlakozik a termékhez.
Ez a termék egy <E> energiahatékonysági osztályú fényforrást tartalmaz.

  A fényforrás nem cserélhető



  Az előtét nem cserélhető.

IS:
Ljósgrafi:
Ljósgrafi er ekki útskipanlegur vegna þess að hann er háður umliggjandi hönnun vörunnar.
Varan inniheldur ljósgrafa í orkuflökki <E>.

  Ekki er hægt að skipta um LED-ljósgrafann.



  Ekki er hægt að skipta um stjórnbúnaðinn.

IT:
Sorgente luminosa:
La sorgente luminosa non è intercambiabile perché è saldamente collegata al prodotto per via del suo design.
Questo prodotto contiene una sorgente luminosa di classe di efficienza energetica <E>.

  La sorgente luminosa a LED non può essere sostituita.



  La centralina non può essere sostituita



LV:
Gaismas avots:
Gaismas avotu nevar nomainīt, jo tas konstrukcijā ir cieši savienots ar izstrādājuma apkārtējo daļu.
Šis ražojums satur gaismas avotu, kura energoefektivitātes klase ir <E>.

  LED apgaismes līdzekļi nevar nomainīt.

  Vadības ierīci nevar nomainīt.



LT:
Šviesos šaltinis:
Šis šviesos šaltinis yra nekeičiamas, nes jis prijungtas prie gaminio pagal jo konstrukciją.
Šiame gaminyje yra šviesos šaltinis, kurio energijos vartojimo efektyvumo klasė <E>.



  LED šviesos šaltinis yra nekeičiamas.

  Valdymo įtaisas yra nekeičiamas.



NL:

Lichtbron:
De lichtbron kan niet worden vervangen, omdat deze vanwege de constructie vast met het product eromheen verbonden is.
Dit product bevat een lichtbron van energie-efficiëntieklasse <E>.

  De LED-lichtbron kan niet worden vervangen.



  Het apparaat kan niet worden vervangen.



NO:
Lyskilde:
Lyskilden kan ikke byttes fordi den sitter fast i produktet.
Dette produktet inneholder en lyskilde i energiklasse <E>.

  LED-lyspæren kan ikke byttes.

  Driverenheten kan ikke byttes.

PL:
Źródło światła:
Źródła światła nie można wymienić, ponieważ jest zintegrowane z produktem ze względu na swoją konstrukcję.
Ten produkt zawiera źródło światła o klasie efektywności energetycznej <E>.

  LED - źródło światła nie może być wymienione.



  Nie można wymienić przekładni sterującej.



PT:
Fonte de Luz:
A fonte de luz não é substituível porque devido às suas características construtivas está fixada de forma permanente ao produto circundante.
Este produto contém uma fonte de luz da classe de eficiência energética <E>.

  Lâmpada não substituível.

  Equipamento de controlo não substituível.

RO:
Sursa de lumina:
Sursa de lumina nu este inlocuibilă ea fiind parte constructivă a produsului Acest produs conține o sursă de lumină cu clasă de eficiență energetică <E>.

  Sursa de lumina nu poate fi inlocuita



  Driverul nu poate fi inlocuit



RUS:
Источник света:
Источник света не является взаимозаменяемым, поскольку это определяется конструкцией смежного продукта.
Данный продукт содержит источник света класса энергоэффективности <E>.

  Светодиодный источник света не подлежит замене.

  Устройство управления не подлежит замене.



SRB:
Izvor svetlosti:
Izvor svetlosti nije zamjenjiv, jer je zbog svog dizajna čvrsto povezan sa proizvodom koji ga okružuje.
Ovaj proizvod sadrži izvor svetlosti klase energetske efikasnosti <E>.

  LED izvor svetlosti nije zamjenjiv.

  Upravljački uređaj nije zamjenjiv.

SK:

Zdroj svetla:
Světelný zdroj nie je možné vymeniť, pretože je vďaka svojej konštrukcii pevne spojený s produktom.
Tento výrobok obsahuje svetelný zdroj triedy energetickej účinnosti <E>.

  Svetelný zdroj nie je vymeniteľný.

  Predradník nie je vymeniteľný.



SL:
Izvor svetlobe:
Vir svetlobe ni zamenljiv, ker je določen z zasnovo izdelka v okolici.
Ta izdelek vsebuje svetlobni vir razreda energetske učinkovitosti <E>.

  Svetlobni vir ni mogoče zamenjati.



  Krnilnik ni mogoče zamenjati.

ES:
Fuente de luz:
La fuente de luz no es sustituible porque está fija en el producto desde la construcción.
Este producto contiene una fuente luminosa de la clase de eficiencia energética <E>.

  Bombilla no reemplazable.



  Dispositivo de control no reemplazable.



SE:
Ljuskälla:
Ljuskällan är inte utbyttbar, eftersom den på grund av konstruktionen är fast integrerad i den omgivande produkten.
Denna produkt innehåller en ljuskälla med energieffektivitetsklass <E>.

  LED-ljuskällan kan inte bytas ut.



  Driftdonet kan inte bytas ut.

TR:
Isik kaynagi:
Konstruksiyon geregi cevreylen urun ile sabit bir sekilde bagli oldugu icin isik kaynagi degistirilemez.
Bu urun, <E> enerji sinifindan bir isik kaynagina sahiptir.

  LED isik kaynagi degistirilemez.

  Isletme cihazi degistirilemez.

UK:
Джерело світла:
Джерело світла не можна обміняти, оскільки воно міцно пов'язане з навколишнім виробом завдяки своїй конструкції.
Цей виріб містить джерело світла класу енергоєфективності <E>.

  джерело світлодіодного світла не можна замінювати.

  пристрій керування не можна замінювати.