

GLOBO

LIGHTING

485250-60SH

smart voice control 

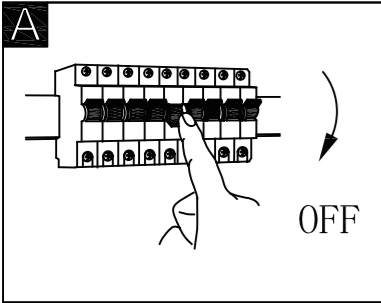

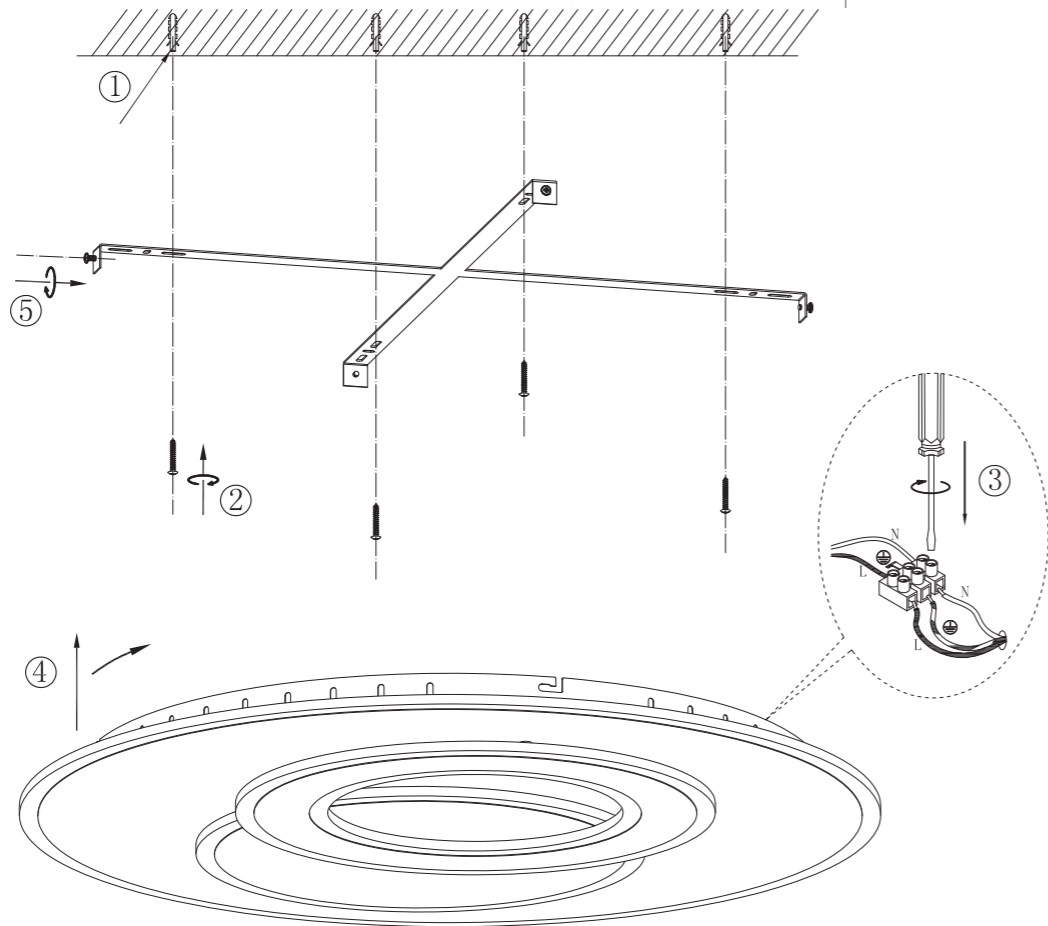

B



- colour change
- incl.
- dimmable
- night light
- LED
- memory function







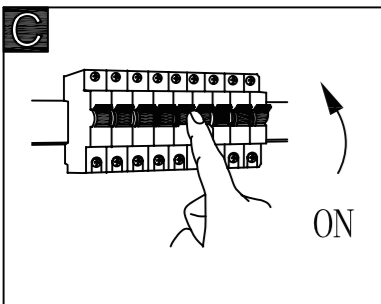

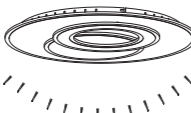

smart APP control

free APP

compatible with Alexa  Powered By 
 compatible with Google Assistant  Intelligence Inside



Frequency Bandwidth	Maximal radiation transmitting power	1x60W LED 37-47V
2400-2483.5MHz	<7dBm	220-240V~ 50/60Hz

	ON Any key	OFF	Lumen 	Lumen 
				
	Kelvin 6500K-Kelvin 2700K	Kelvin 2700K-Kelvin 6500K	Kelvin 2700K-4000K-6500K	Night light
				 10%

Download Tuya App:



Get latest manual:



Functional Video:



Tuya App - Pairing Process

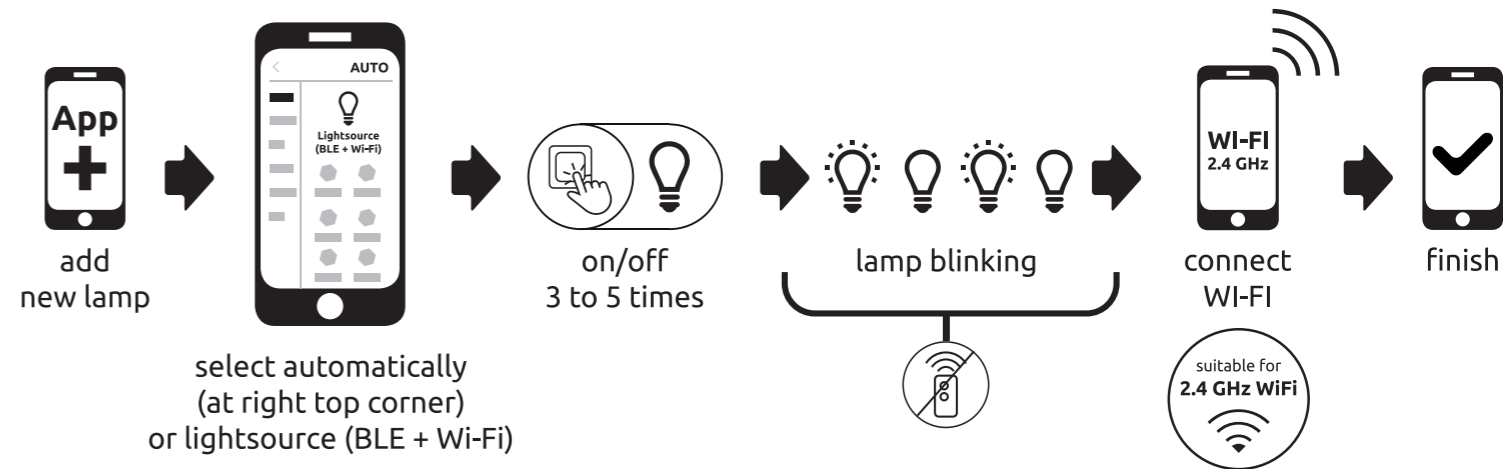

08:00 to 16:00
(Monday to Friday)



+43 (0)4253 320 50 083

(Please consider, your telephone operator's usual charges for calls to Austria will apply.)

GLOBO Handels GmbH
Gwerbestrasse 3
A-9184 Sankt Peter, AUSTRIA
www.globo-lighting.com

