

GLOBO

LIGHTING

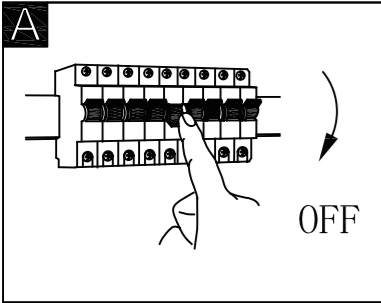





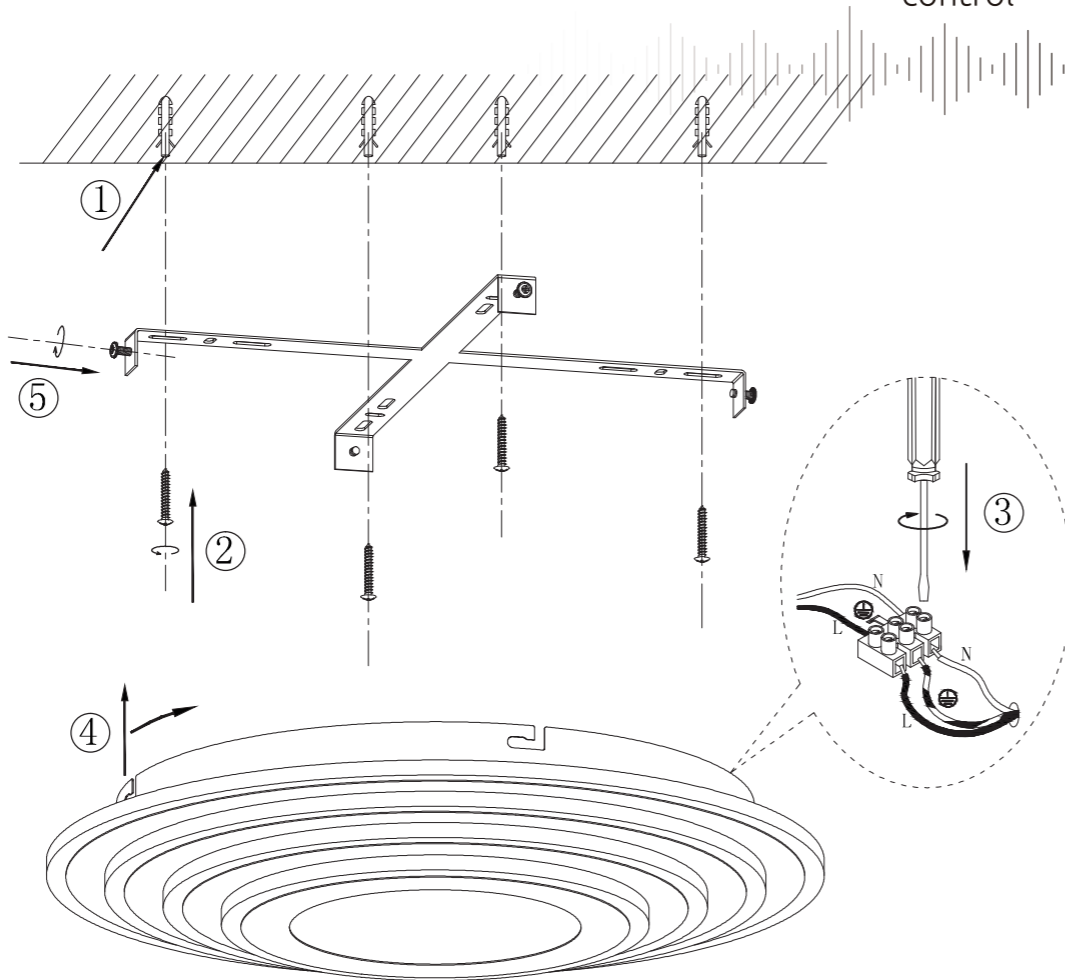

48544-40SH

smart voice control 







B





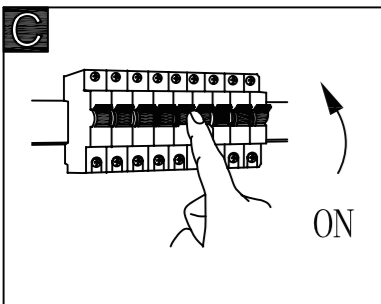

-  3 LIGHT STEPS 2700 K - 6500 K
-  APP
-  2700 K - 6500 K
-  dimmmable
-  incl.
-  memory function
-  many steps
-  night light

smart APP control

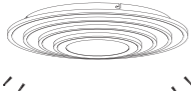
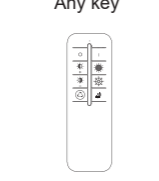
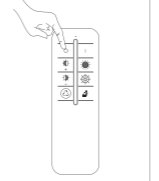
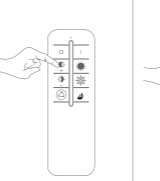
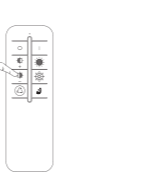
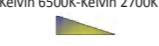
- free APP
- compatible with Alexa 
- compatible with Google Assistant 
- Powered By  tuya
- Intelligence Fusion 

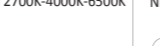

Battery type 2 X AAA incl.		Frequency Bandwidth 2400-2483.5MHz	Maximal radiation transmitting power <7dBm	1x40W LED 40-47V 220-240V~ 50/60Hz
ON	Any key	OFF	Lumen	Lumen
				
	Kelvin 6500K-Kelvin 2700K	Kelvin 2700K-Kelvin 6500K	Kelvin 2700K-4000K-6500K	Night light
				
				10%

GLOBO Handels GmbH
Gwerbestrasse 3
A-9184 Sankt Peter, AUSTRIA
www.globo-lighting.com
office@globo-lighting.com

Download Tuya App:



Get latest manual:



Functional Video:



Tuya App - Pairing Process

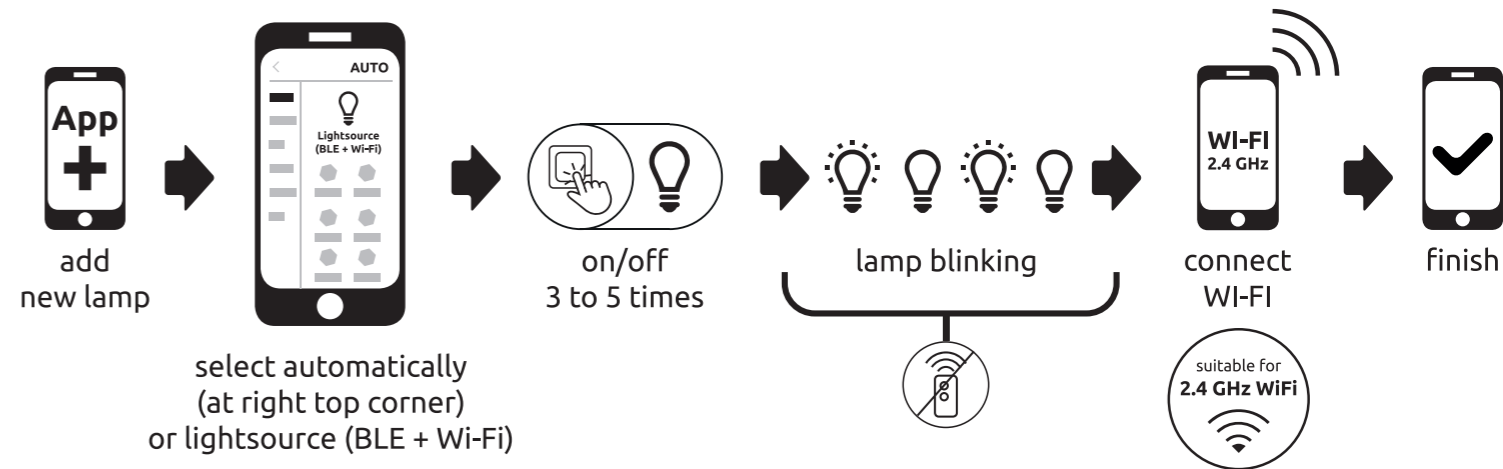

08:00 to 16:00
(Monday to Friday)



+43 (0)4253 320 50 083

(Please consider, your telephone operator's usual charges for calls to Austria will apply.)

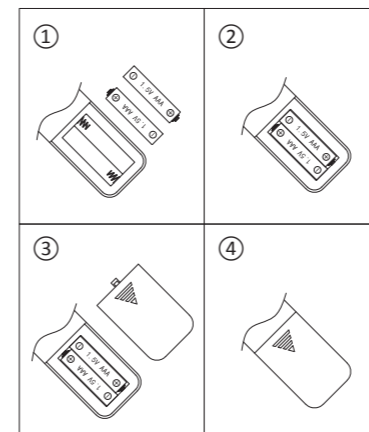

BATTERY DATA

2xAAA dry battery* incl.

*Manufacture: ChangZhou JiangNan Battery Co., Ltd.

Address: No.5 DongFang Road, HengShanQiao Town, ChangZhou City, JiangSu Province, China

Model: R03 1.5V 200mAh

SAFETY INSTRUCTIONS



Lichtquelle / Light Source:

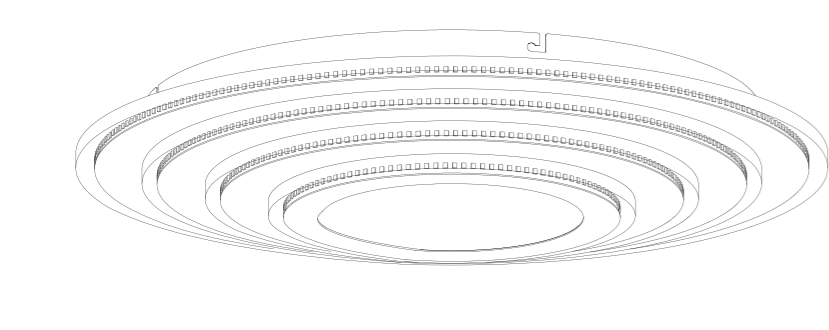



DEU:

Lichtquelle:

Die Lichtquelle ist nicht tauschbar, weil sie konstruktionsbedingt fest mit dem umgebenden Produkt verbunden ist.

Dieses Produkt enthält eine Lichtquelle der Energieeffizienzklasse <F>.

	Das Betriebsgerät ist nicht austauschbar.
--	---

	Die LED - Lichtquelle ist nicht austauschbar.
--	---

GBR:

Light source:

The light source is not interchangeable because it is determined by the surrounding product design.

This product contains a light source of energy efficiency class <F>.

	The control gear cannot be replaced.
--	--------------------------------------

	The LED - light source cannot be replaced.
--	--

BIH & HR:

Izvor svjetla :

Izvor svjetla nije zamjenjiv , jer je konstrukcijski pričvršćen na proizvod .

Ovaj proizvod sadržava izvor svjetlosti klase energetske učinkovitosti <F>.

	Pogonski uređaj se ne može zamjeniti .
---	--

	LED –izvor svjetla nije moguće zamjeniti
--	--

BG:

Източник на светлина:

Източникът на светлина не може да се подменя, тъй като поради конструкцията си е трайно фиксиран към заобикалящия го продукт.

Този продукт включва светлинен източник с клас на енергийна ефективност <F>.

	Устройството за управление не може да се подменя.
--	---

	LED източникът на светлина не може да се подменя.
--	---

CZ:

Zdroj světla:

Světelný zdroj není možné vyměnit, protože je díky své konstrukci pevně spojený s produktem.

Tento výrobek obsahuje světelný zdroj s třídou energetické účinnosti <F>.

	Předřadník není vyměnitelný.
--	------------------------------

	Světelný zdroj není vyměnitelný.
--	----------------------------------

DK:

Lyskilde:

Lyskilden kan ikke udskiftes, fordi den er fast forbundet med det omgivende produkt.

Dette produkt indeholder en lyskilde i energieffektivitetsklasse < F >.

	Driftsenheden kan ikke udskiftes.
--	-----------------------------------

	LED- lyskilden kan ikke udskiftes.
--	------------------------------------

ET:

Valgusallikas:

Valgusallikas ei ole välja vahetatav, sest ta on tooteга ehituslikult kindlalt seotud.

Toode sisaldab energiatõhususe klassi <F> valgusallikat.

	Juhtseadet ei saa asendada.
--	-----------------------------

	LED - valgusallikat ei saa asendada.
--	--------------------------------------

ES:

Fuente de luz:

La fuente de luz no es sustituible porque está fija en el producto desde la construcción.

Este producto contiene una fuente luminosa de la clase de eficiencia energética <F>.

	Dispositivo de control no reemplazable.
--	---

	Bombilla no reemplazable.
--	---------------------------

FI:

Valonlähde:

Valonlähdettä ei voi vaihtaa uuteen, sillä se on rakenteellisesti yhdistetty ympäröivään tuotteeseen.

Tämä tuote sisältää valonlähteen, jonka energiatehokkuusluokka on <F>.

	Liitäntälaitetta ei voi vaihtaa uuteen.
---	---

	LED-valonlähdettä ei voi vaihtaa uuteen.
---	--

FR:

Source lumineuse:

La source lumineuse n'est pas remplaçable car elle est, de par la construction du produit, liée de façon permanente à celui-ci.

Ce produit contient une source lumineuse de classe d'efficacité énergétique <F>.

	L'unité de contrôle n'est pas remplaçable.
---	--

	La source lumineuse LED n'est pas remplaçable.
---	--

GR:

Φωτεινή πηγή:

Η φωτεινή πηγή δεν μπορεί να αντικατασταθεί, επειδή είναι για κατασκευαστικούς λόγους σταθερά συνδεδεμένη με το προϊόν που την περιβάλλει.

Το προϊόν αυτό περιέχει φωτεινή πηγή της τάξης ενεργειακής απόδοσης <F>.

	Η λειτουργική συσκευή δεν αντικαθίσταται.
---	---

	Η φωτεινή πηγή LEDδεν αντικαθίσταται.
---	---------------------------------------

HU:

Fényforrás:

A fényforrás nem cserélhető, mert felépítése miatt szilárdan csatlakozik a termékhez

Ez a termék egy <F> energiahatékonysági osztályú fényforrást tartalmaz.

	Az előtét nem cserélhető.
---	---------------------------

	A fényforrás nem cserélhető
---	-----------------------------

Isländisch/IS:

Ljósgjafi:

Ljósgjafinn er ekki útskiptanlegur vegna þess að hann er háður umliggjandi hönnun vörunnar.

Varan inniheldur ljósgjafa í orkuflokki <F>.

	Ekki er hægt að skipta um stjórnbúnaðinn.
--	---

	Ekki er hægt að skipta um LED-ljósgjafann.
---	--

IT:

Sorgente luminosa:

La sorgente luminosa non è intercambiabile perché è saldamente collegata al prodotto per via del suo design.

Questo prodotto contiene una sorgente luminosa di classe di efficienza energetica <F>.

	La centralina non può essere sostituita
---	---

	La sorgente luminosa a LED non può essere sostituita.
---	---

LV:

Gaismas avots:

Gaismas avotu nevar nomainīt, jo tas konstrukcijā ir cieši savienots ar izstrādājuma apkārtējo daļu.

Šis ražojums satur gaismas avotu, kura energoefektivitātes klase ir <F>.

	Vadības ierīci nevar nomainīt.
---	--------------------------------

	LED apgaismes līdzekli nevar nomainīt.
---	--

LT:

Šviesos šaltinis:

Šis šviesos šaltinis yra nekeičiamas, nes jis prijungtas prie gaminio pagal jo konstrukciją.

Šiame gaminyje yra šviesos šaltinis, kurio energijos vartojimo efektyvumo klasė <F>.

	Vadības ierīci nevar nomainīt.
---	--------------------------------

	LED šviesosšaltinisyraneičiamas.
---	----------------------------------

NL:

Lichtbron:

De lichtbron kan niet worden vervangen, omdat deze vanwege de constructie vast met het product eromheen verbonden is.

Dit product bevat een lichtbron van energie-efficiëntieklasse <F>.

	Het apparaat kan niet worden vervangen.
---	---

	De LED-lichtbron kan niet worden vervangen.
---	---

Norwegisch/Norwegian / NO:

Lyskilde:

Lyskilden kan ikke byttes fordi den sitter fast i produktet.

Dette produktet inneholder en lyskilde i energiklasse <F>.

	Driverenheten kan ikke byttes.
---	--------------------------------

	LED-lyspæren kan ikke byttes.
---	-------------------------------

PL:

Źródło światła:

Źródła światła nie można wymenić, ponieważ jest zintegrowane z produktem ze względu na swoją konstrukcję.

Ten produkt zawiera źródło światła o klasie efektywności energetycznej <F>.

	Niemoznawymienićprzekładnisterującej.
---	---------------------------------------

	LED - źródłoswiatłaniemożebyćwymienione.
---	--

PT:

Fonte de Luz:

A fonte de luz não é substituível porque devido às suas características construtivas está fixada de forma permanente ao produto circundante.

Este produto contém uma fonte de luz da classe de eficiência energética <F>.

	Equipamento de controlo não substituível.
---	---

	Lâmpada não substituível.
---	---------------------------

RO:

Sursa de lumina:

Sursa de lumina nu este inlocuibila ea fiind parte constructiva a produsului

Acest produs conține o sursă de lumină cu clasa de eficiență energetică <F>.

	Driverul nu poate fi inlocuit
---	-------------------------------

	Sursa de lumina nu poate fi inlocuita
---	---------------------------------------

RUS:

Источник света:

Источник света не является взаимозаменяемым, поскольку это определяется конструкцией смежного продукта.

Данный продукт содержит источник света класса энергоэффективности <F>.

	Устройство управления не подлежит замене.
---	---

	Светодиодный источник света не подлежит замене.
---	---

SRB:

Izvor svetlosti:

Izvor svetlosti nije zamenljiv, jer je zbog svog dizajna čvrsto povezan sa proizvodom koji ga opkružuje.

Ovaj proizvod sadrži izvor svetlosti klase energetske efikasnosti <F>.

	Upravljački uređaj nije zamenljiv.
--	------------------------------------

	LED izvor svetlosti nije zamenljiv.
---	-------------------------------------

SK:

Zdroj svetla:

Svetelný zdroj nie je možné vymeniť, pretože je vďaka svojej konštrukcii pevne spojený s produktom.

Tento výrobok obsahuje svetelný zdroj triedy energetickej účinnosti <F>.

	Predradníknie je vymeniteľný.
---	-------------------------------

	Svetelný zdroj nie je vymeniteľný.
---	------------------------------------

SI:

Izvor svetlobe:

Vir svetlobe ni zamenljiv, ker je določen z zasnovo izdelka v okolici.

Ta izdelek vsebuje svetlobni vir razreda enerjske učinkovitosti <F>.

	Krmilniknimožeozamenjati.
---	---------------------------

	Svetlobnivirmimožeozamenjati.
---	-------------------------------

SE:

Ljuskälla:

Ljuskällan är inte utbytbar, eftersom den på grund av konstruktionen är fast integrerad i den omgivande produkten.

Denna produkt innehåller en ljuskälla med energieffektivitetsklass <F>.

	Driftdonet kan inte bytas ut.
---	-------------------------------

	LED-ljuskällan kan inte bytas ut.
---	-----------------------------------

TR:

Işık kaynağı:

Konstrüksiyon gereği çevreleyen ürün ile sabit bir şekilde bağlı olduđu için ışık kaynağı deđiştirilemez.

Bu ürün, <F>enerji sınıfından bir ışık kaynađına sahiptir.

	İşletme cihazı deđiştirilemez.
---	--------------------------------

	LED ışık kaynağı deđiştirilemez.
---	----------------------------------

UK:

Джерелосвітла:

Джерелосвітланеможаобмінати, оскількивономіцнопов'язанезнавколишнімвиробомзавдякисвоїйконструкції.

Цей виріб містить джерело світла класу енергоефективності <F>.

	пристрійкеруванняне можназамінювати.
---	--------------------------------------

	джерелосвітлодіодногосвітла неможназамінювати.
---	--