

# GLOBO

LIGHTING

## 48547SH

smart voice control 

Download Tuya App:



Get latest manual:



Functional Video:



### Tuya App - Pairing Process

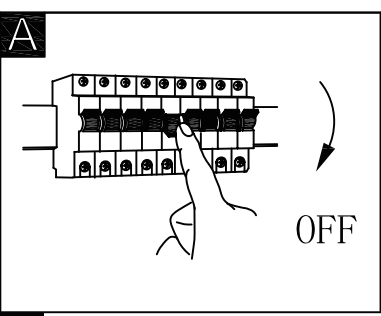
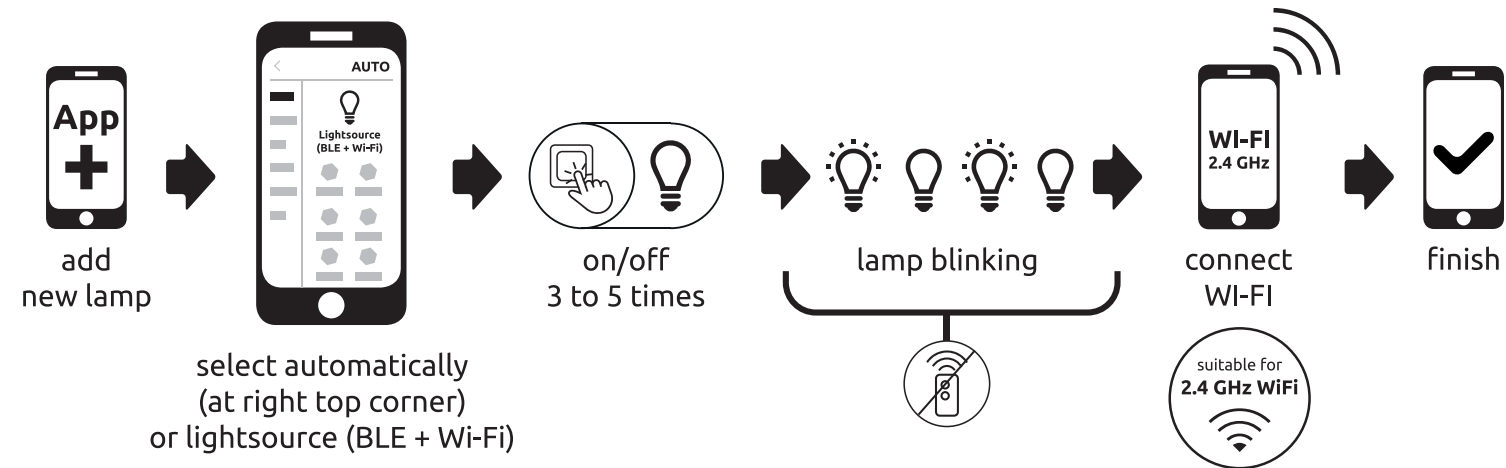

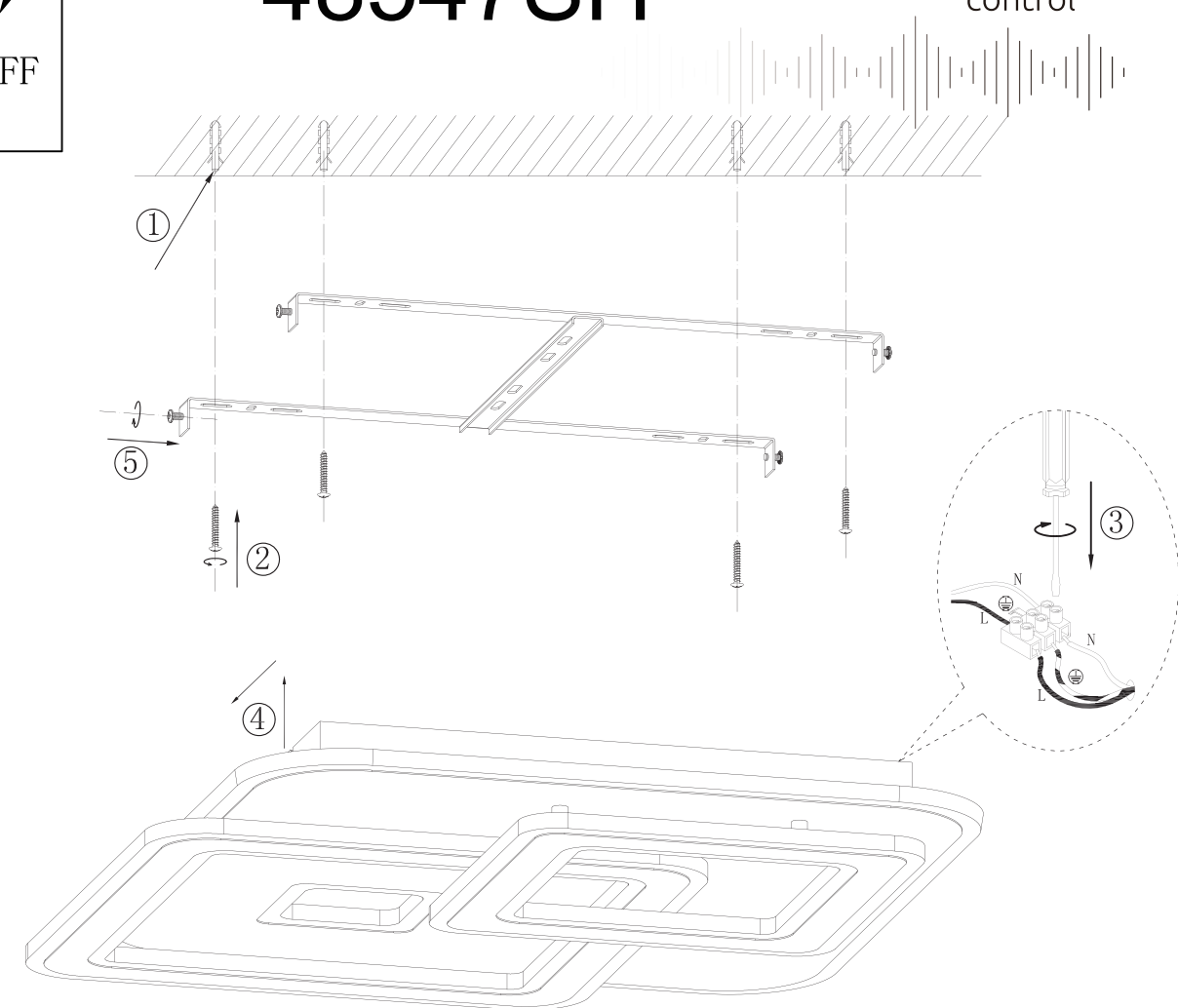

- B**
- 3 LIGHT STEPS (3000 K - 6500 K)
  - APP
  - 3000 K - 6500 K
  - dimmable
  - incl.
  - memory function
  - many steps
  - night light



smart APP control

free APP

compatible with Alexa  Powered By  

compatible with Google Assistant

Frequency Bandwidth	Maximal radiation transmitting power	1x50W LED 40-48V 220-240V~ 50/60Hz
2400-2483.5MHz	<7dBm	

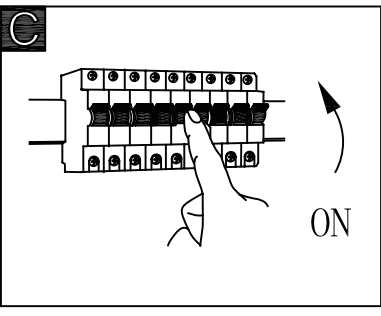
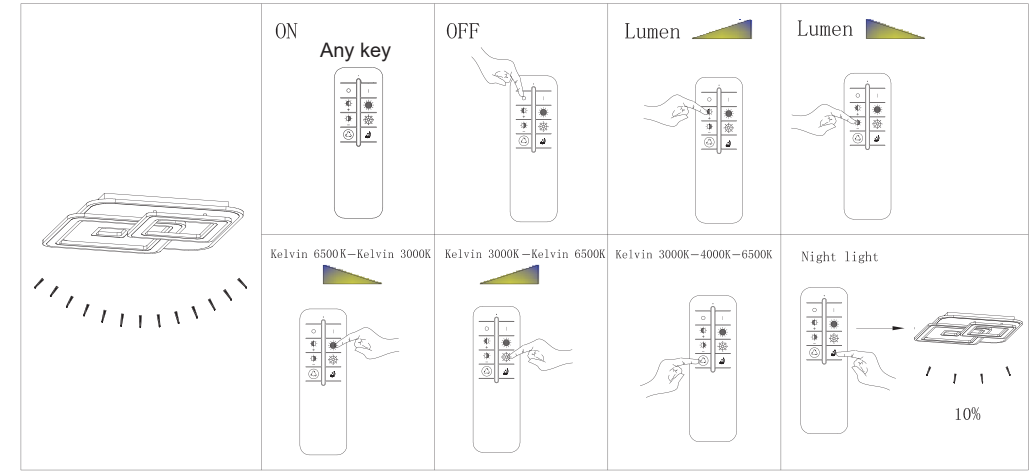

08:00 to 16:00  
(Monday to Friday)

**+43 (0)4253 320 50 083**

(Please consider, your telephone operator's usual charges for calls to Austria will apply.)

GLOBO Handels GmbH  
 Gewerbestrasse 3  
 A-9184 Sankt Peter, AUSTRIA  
 www.globo-lighting.com  
 office@globo-lighting.com

