

GLOBO

LIGHTING

48548SH

smart voice control 

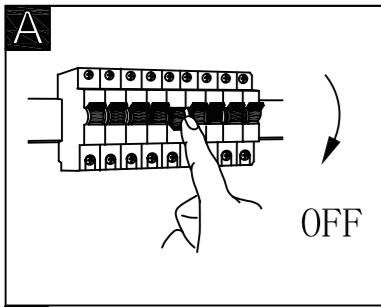

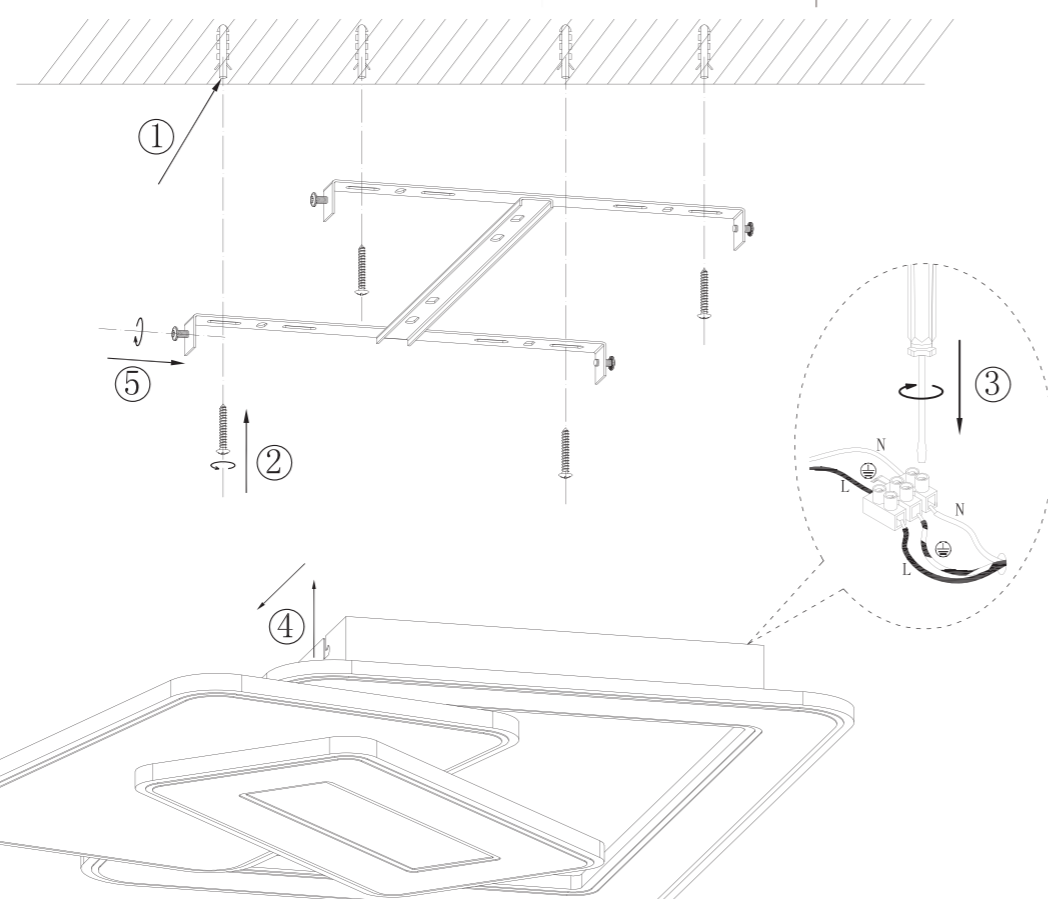

B



- 3 LIGHT STEPS (3000 K, 4000 K, 6500 K)
- APP
- 3000 K - 6500 K
- dimmable
- incl.
- memory function
- many steps
- night light

smart APP control



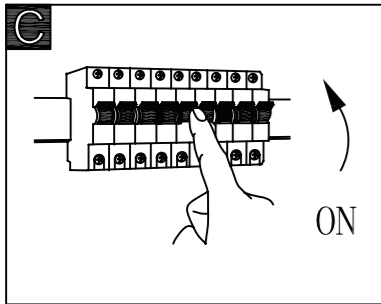

free APP

compatible with Alexa  Powered By  **tuya**

compatible with Google Assistant  Intelligence Inside

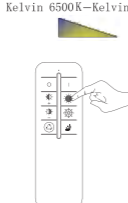
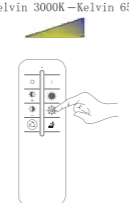
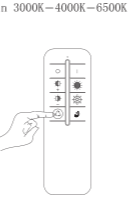
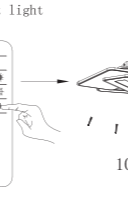
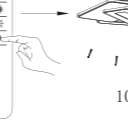

Frequency Bandwidth	Maximal radiation transmitting power	1x50W LED 37-47V 220-240V~ 50/60Hz
2400-2483.5MHz	<7dBm	

ON Any key 	OFF 	Lumen 	Lumen 
			
Kelvin 6500K-Kelvin 3000K	Kelvin 3000K-Kelvin 6500K	Kelvin 3000K-4000K-6500K	Night light  10%

Download Tuya App:



Get latest manual:



Functional Video:



Tuya App - Pairing Process

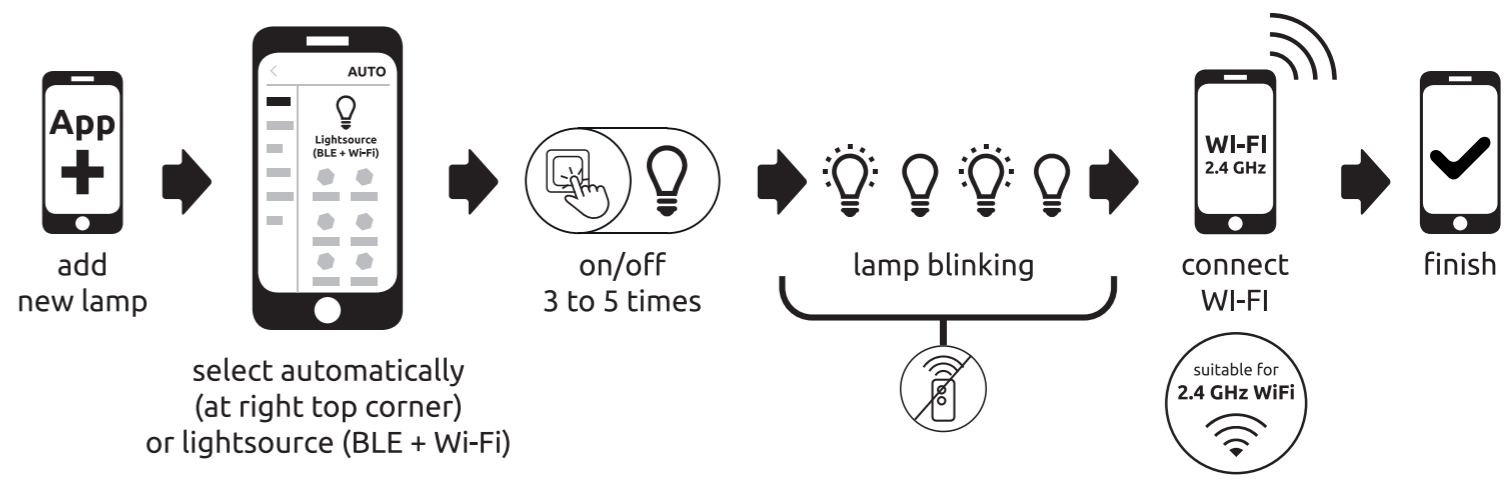

08:00 to 16:00
(Monday to Friday)

+43 (0)4253 320 50 083

(Please consider, your telephone operator's usual charges for calls to Austria will apply.)

GLOBO Handels GmbH
 Gewerbestrasse 3
 A-9184 Sankt Peter, AUSTRIA
 www.globo-lighting.com
 office@globo-lighting.com

Lichtquelle / Light Source:

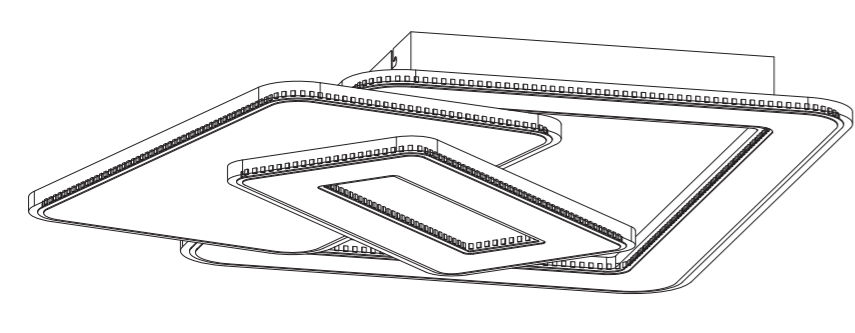



DEU:
Lichtquelle:
Die Lichtquelle ist nicht tauschbar, weil sie konstruktionsbedingt fest mit dem umgebenden Produkt verbunden ist.
Dieses Produkt enthält eine Lichtquelle der Energieeffizienzklasse <E>.

 Das Betriebsgerät ist nicht austauschbar.

 Die LED - Lichtquelle ist nicht austauschbar.

GBR:
Light source:
The light source is not interchangeable because it is determined by the surrounding product design.
This product contains a light source of energy efficiency class <E>.

 The control gear cannot be replaced.

 The LED - light source cannot be replaced.

BIH & HR:
Izvor svjetla :
Izvor svjetla nije zamjenjiv , jer je konstrukcijski pričvršćen na proizvod .
Ovaj proizvod sadržava izvor svjetlosti klase energetske učinkovitosti <E>.

 Pogonski uređaj se ne može zamjeniti .

 LED –izvor svjetla nije moguće zamjeniti

BG:
Източник на светлина:
Източникът на светлина не може да се подменя, тъй като поради конструкцията си е трайно фиксиран към заобикалящия го продукт.
Този продукт включва светлинен източник с клас на енергийна ефективност <E>.

 Устройството за управление не може да се подменя.

 LED източникът на светлина не може да се подменя.

CZ:
Zdroj světla:
Světelný zdroj není možné vyměnit, protože je díky své konstrukci pevně spojený s produktem.
Tento výrobek obsahuje světelný zdroj s třídou energetické účinnosti <E>.

 Předřadník není vyměnitelný.

 Světelný zdroj není vyměnitelný.

DK:
Lyskilde:
Lyskilden kan ikke udskiftes, fordi den er fast forbundet med det omgivende produkt.
Dette produkt indeholder en lyskilde i energieffektivitetsklasse < E >.

 Driftsenheden kan ikke udskiftes.

 LED- lyskilden kan ikke udskiftes.

ET:
Valgusallikas:
Valgusallikas ei ole välja vahetatav, sest ta on tootega ehituslikult kindlalt seotud.
Toode sisaldab energiatõhususe klassi <E> valgusallikat.

 Juhtseadet ei saa asendada.

 LED - valgusallikat ei saa asendada.

ES:
Fuente de luz:
La fuente de luz no es sustituable porque está fija en el producto desde la construcción.
Este producto contiene una fuente luminosa de la clase de eficiencia energética <E>.

 Dispositivo de control no reemplazable.

 Bombilla no reemplazable.

FI:
Valonlähde:
Valonlähdettä ei voi vaihtaa uuteen, sillä se on rakenteellisesti yhdistetty ympäröivään tuotteeseen.
Tämä tuote sisältää valonlähteen, jonka energiatehokkuusluokka on <E>.

 Liitäntälaitetta ei voi vaihtaa uuteen.

 LED-valonlähdettä ei voi vaihtaa uuteen.

FR:
Source lumineuse:
La source lumineuse n'est pas remplaçable car elle est, de par la construction du produit, liée de façon permanente à celui-ci.
Ce produit contient une source lumineuse de classe d'efficacité énergétique <E>.

 L'unité de contrôle n'est pas remplaçable.

 La source lumineuse LED n'est pas remplaçable.

GR:
Φωτεινή πηγή:
Η φωτεινή πηγή δεν μπορεί να αντικατασταθεί, επειδή είναι για κατασκευαστικούς λόγους σταθερά συνδεδεμένη με το προϊόν που την περιβάλλει.
Το προϊόν αυτό περιέχει φωτεινή πηγή της τάξης ενεργειακής απόδοσης <E>.

 Η λειτουργική συσκευή δεν αντικαθίσταται.

 Η φωτεινή πηγή LEDδεν αντικαθίσταται.

HU:
Fényforrás:
A fényforrás nem cserélhető, mert felépítése miatt szilárdan csatlakozik a termékhez.
Ez a termék egy <E> energiahatékonysági osztályú fényforrást tartalmaz.

 Az előtét nem cserélhető.

 A fényforrás nem cserélhető

Isländisch/IS:
Ljósgjafi:
Ljósgjafinn er ekki útskiptanlegur vegna þess að hann er háður umliggjandi hönnun vörunnar.
Varan inniheldur ljósgjafa í orkuflokki <E>.

 Ekki er hægt að skipta um stjórnbúnaðinn.

 Ekki er hægt að skipta um LED-ljósgjafann.

IT:
Sorgente luminosa:
La sorgente luminosa non è intercambiabile perché è saldamente collegata al prodotto per via del suo design.
Questo prodotto contiene una sorgente luminosa di classe di efficienza energetica <E>.

 La centralina non può essere sostituita

 La sorgente luminosa a LED non può essere sostituita.

LV:
Gaismas avots:
Gaismas avotu nevar nomainīt, jo tas konstrukcijā ir cieši savienots ar izstrādājuma apkārtējo daļu.
Šis ražojums satur gaismas avotu, kura energoefektivitātes klase ir <E>.

 Vadības ierīci nevar nomainīt.

 LED apgaismes līdzekli nevar nomainīt.

LT:
Šviesos šaltinis:
Šis šviesos šaltinis yra nekeičiamas, nes jis prijungtas prie gaminio pagal jo konstrukciją.
Šiame gaminyje yra šviesos šaltinis, kurio energijos vartojimo efektyvumo klasė <E>.

 Vadības ierīci nevar nomainīt.

 LED šviesosšaltinisyra nekeičiamas.

NL:
Lichtbron:
De lichtbron kan niet worden vervangen, omdat deze vanwege de constructie vast met het product eromheen verbonden is.
Dit product bevat een lichtbron van energie-efficiëntieklasse <E>.

 Het apparaat kan niet worden vervangen.

 De LED-lichtbron kan niet worden vervangen.

Norwegisch/Norwegian / NO:

Lyskilde:
Lyskilden kan ikke byttes fordi den sitter fast i produktet.
Dette produktet inneholder en lyskilde i energiklasse <E>.

 Drivereenheten kan ikke byttes.

 LED-lyspæren kan ikke byttes.

PL:
Źródło światła:
Źródła światła nie można wymienić, ponieważ jest zintegrowane z produktem ze względu na swoją konstrukcję.
Ten produkt zawiera źródło światła o klasie efektywności energetycznej <E>.

 Niemożnawymienićprzekładnisterującej.

 LED - źródłoswiatłaniemożebyćwymienione.

PT:
Fonte de Luz:
A fonte de luz não é substituível porque devido às suas características construtivas está fixada de forma permanente ao produto circundante.
Este produto contém uma fonte de luz da classe de eficiência energética <E>.

 Equipamento de controlo não substituível.

 Lâmpada não substituível.

RO:
Sursa de lumina:
Sursa de lumina nu este inlocuibilă ea fiind parte constructivă a produsului.
Acest produs conține o sursă de lumină cu clasa de eficiență energetică <E>.

 Driverul nu poate fi inlocuit

 Sursa de lumina nu poate fi inlocuită

RUS:
Источник света:
Источник света не является взаимозаменяемым, поскольку это определяется конструкцией смежного продукта.
Данный продукт содержит источник света класса энергоэффективности <E>.

 Устройство управления не подлежит замене.

 Светодиодный источник света не подлежит замене.

SRB:
Izvor svetlosti:
Izvor svetlosti nije zamenljiv, jer je zbog svog dizajna čvrsto povezan sa proizvodom koji ga opkrružuje.
Ovaj proizvod sadrži izvor svetlosti klase energetske efikasnosti <E>.

 Upravljački uređaj nije zamenljiv.

 LED izvor svetlosti nije zamenljiv.

SK:
Zdroj svetla:
Svetelný zdroj nie je možné vymeniť, pretože je vďaka svojej konštrukcii pevne spojený s produktom.
Tento výrobok obsahuje svetelný zdroj triedy energetickej účinnosti <E>.

 Predradníknie je vymeniteľný.

 Svetelný zdroj nie je vymeniteľný.

SI:
Izvor svetlobe:
Vir svetlobe ni zamenljiv, ker je določen z zasnovo izdelka v okolici.
Ta izdelek vsebuje svetlobni vir razreda energijske učinkovitosti <E>.

 Krmilniknimožeozamenjati.

 Svetlobnivirmimožeozamenjati.

SE:
Ljuskälla:
Ljuskällan är inte utbytbar, eftersom den på grund av konstruktionen är fast integrerad i den omgivande produkten.
Denna produkt innehåller en ljuskälla med energieffektivitetsklass <E>.

 Driftdonet kan inte bytas ut.

 LED-ljuskällan kan inte bytas ut.

TR:
Işık kaynağı:
Konstrüksiyon gereği çevreleyen ürün ile sabit bir şekilde bağlı olduđu için ışık kaynağı deđiştirilemez.
Bu ürün, <E>enerji sınıfından bir ışık kaynağına sahiptir.

 İşletme cihazı deđiştirilemez.

 LED ışık kaynağı deđiştirilemez.

UK:
Джерелосвітла:
Джерелосвітланеможнаобмінати, оскількивномоцінопов’язанезнавколишнімвиробомзавдякисвоїйконструкції.
Цей виріб містить джерело світла класу енергоефективності <E>.

 пристрійкеруванняне можназамінювати.

 джерелосвітлодіодногосвітла неможназамінювати.