

# GLOBO

LIGHTING

## 58434K

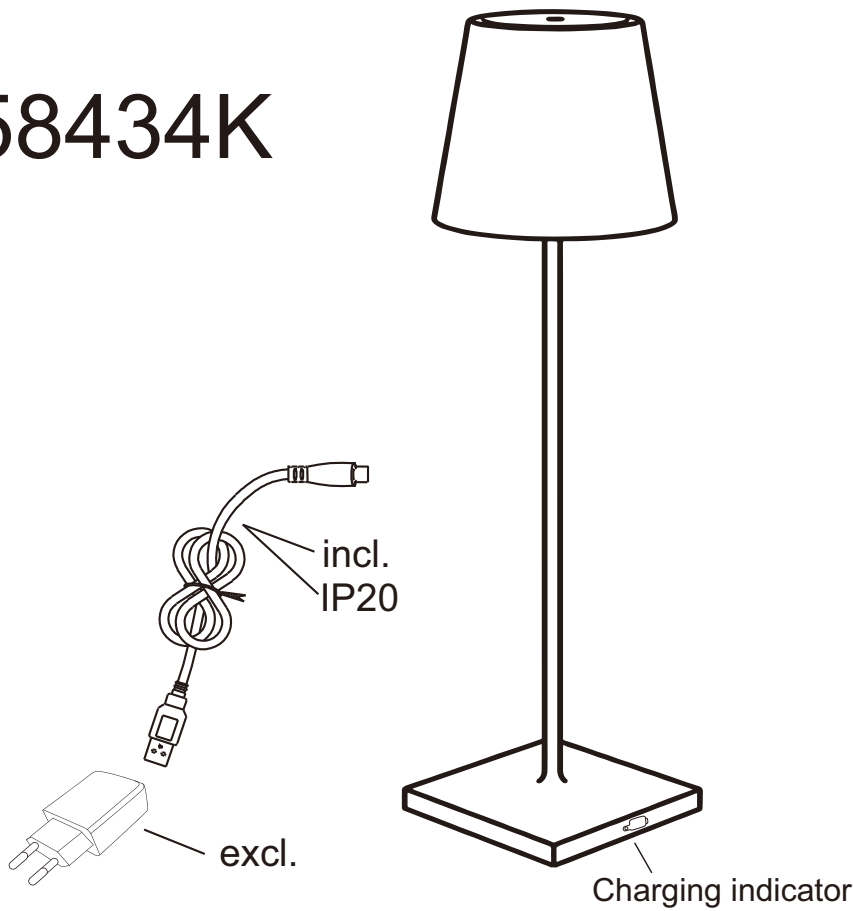

- IP44
- ~5-6 hours
- touch on|off
- USB charger
- continuous touch dimmer
- adapter excl.
- 5000 K 3 LIGHT STEPS 4000 K 3000 K
- AKKU incl.

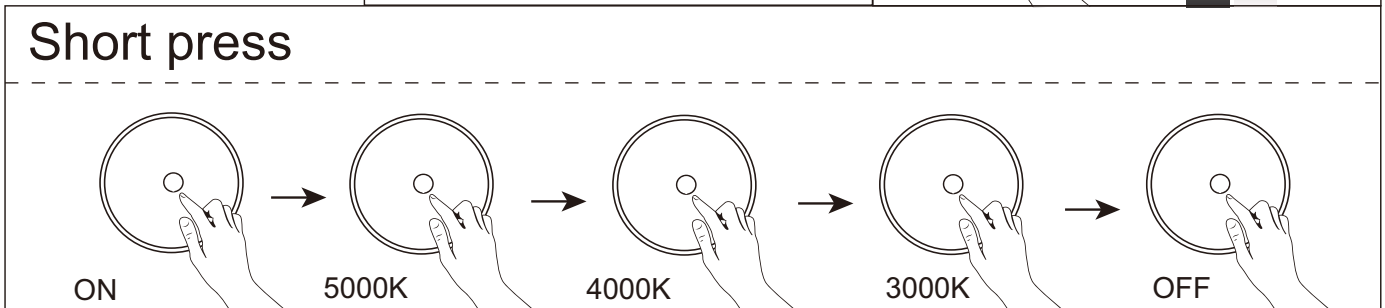
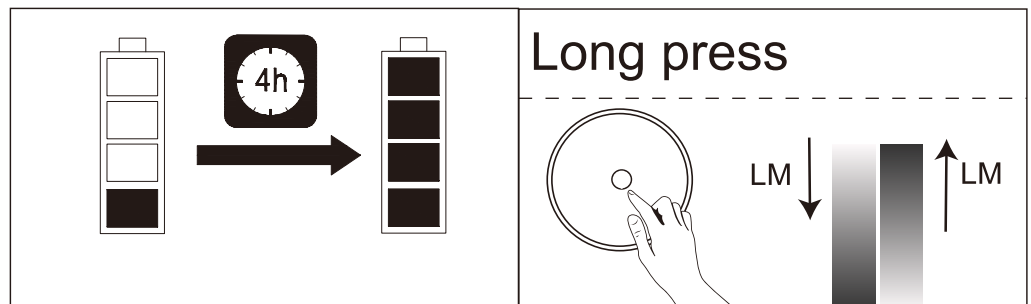

GLOBO Handels GmbH  
Gewerbestr. 3 A-9184 Sankt Peter, Austria  
www.globo-lighting.com | office@globo-lighting.com

1 x MAX 4W LED DC 5V  
2 x 3.7V 1800mAh Li-ion incl

## Lichtquelle:

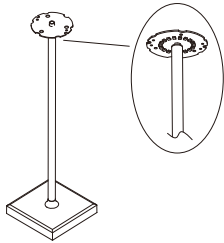

### DEU

#### Lichtquelle:

Die Lichtquelle ist nicht tauschbar, weil sie konstruktionsbedingt fest mit dem umgebenden Produkt verbunden ist.

Dieses Produkt enthält eine Lichtquelle der Energieeffizienzklasse <G>.



   Die LED - Lichtquelle ist nicht austauschbar.

### GBR

#### Light source:

The light source is not interchangeable because it is determined by the surrounding product design.



This product contains a light source of energy efficiency class <G>.

   The LED - light source cannot be replaced.

### BG:

#### Източник на светлина:

Източникът на светлина не може да се подменя, тъй като поради конструкцията си е трайно фиксиран към заобикалящия го продукт. Този продукт включва светлинен източник с клас на енергийна ефективност <G>.



   LED източникът на светлина не може да се подменя.

### BIH

#### Izvor svjetla :

Izvor svjetla nije zamjenjiv , jer je konstrukcijski pričvršćen na proizvod.

Ovaj proizvod sadrži izvor svjetlosti klase energetske učinkovitosti <G>.



   LED – izvor svjetla nije moguće zamjeniti

### CZ:

#### Zdroj světla:

Světelný zdroj není možné vyměnit, protože je díky své konstrukci pevně spojený s produktem.

Tento výrobek obsahuje světelný zdroj s třídou energetické účinnosti <G>.



   Světelný zdroj není vyměnitelný.

### DK:

#### Lyskilde:

Lyskilden kan ikke udskiftes, fordi den er fast forbundet med det omgivende produkt.

Dette produkt indeholder en lyskilde i energieffektivitetsklasse < G > .

   LED- lyskilden kan ikke udskiftes.

### ET:

#### Valgusallikas:

Valgusallikas ei ole välja vahetatav, sest ta on tootega ehituslikult kindlalt seotud.

Toode sisaldab energiatõhususe klassi <G> valgusallikat.

   LED - valgusallikat ei saa asendada.

### ES:

#### Fuente de luz:

La fuente de luz no es sustituible porque está fija en el producto desde la construcción.

Este producto contiene una fuente luminosa de la clase de eficiencia energética <G>.

   Bombilla no reemplazable.

### FI:

#### Valonlähde:

Valonlähde ei voi vaihtaa uuteen, sillä se on rakenteellisesti yhdistetty ympäröivään tuotteeseen.

Tämä tuote sisältää valonlähteen, jonka energiatehokkuusluokka on <G>.

   LED-valonlähde ei voi vaihtaa uuteen.

### PL:

#### Źródło światła:

Źródła światła nie można wymienić, ponieważ jest zintegrowane z produktem ze względu na swoją konstrukcję.

Ten produkt zawiera źródło światła o klasie efektywności energetycznej <G>.

   LED - źródło światła nie może być wymienione.

### PT:

#### Fonte de Luz:

A fonte de luz não é substituível porque devido às suas características construtivas está fixada de forma permanente ao produto circundante.

Este produto contém uma fonte de luz da classe de eficiência energética <G>.



   Lâmpada não substituível.

### FR:

#### Source lumineuse:

La source lumineuse n'est pas remplaçable car elle est, de par la construction du produit, liée de façon permanente à celui-ci.

Ce produit contient une source lumineuse de classe d'efficacité énergétique <G>.



   La source lumineuse LED n'est pas remplaçable.

### GR:

#### Φωτεινή πηγή:

Η φωτεινή πηγή δεν μπορεί να αντικατασταθεί, επειδή είναι για κατασκευαστικούς λόγους σταθερά συνδεδεμένη με το προϊόν που την περιβάλλει.

Το προϊόν αυτό περιέχει φωτεινή πηγή της τάξης ενεργειακής απόδοσης <G>.



   Η φωτεινή πηγή LED δεν αντικαθίσταται.

### HR:

#### Izvor svjetla :

Izvor svjetla nije zamjenjiv , jer je konstrukcijski pričvršćen na proizvod .

Ovaj proizvod sadrži izvor svjetlosti klase energetske učinkovitosti <G>.

   LED – izvor svjetla nije moguće zamjeniti

### HU:

#### Fényforrás:



A fényforrás nem cserélhető, mert felépítése miatt szilárdan csatlakozik a termékhez. Ez a termék egy <G> energiahatékonysági osztályú fényforrást tartalmaz.

   A fényforrás nem cserélhető

### IS:

#### Ljósgrjafi:

Ljósgrjafinn er ekki útskiptanlegur vegna þess að hann er háður umliggjandi hönnun vörunnar. Varan inniheldur ljósgrjafa í orkuflokki <G>.



   Ekki er hægt að skipta um LED-ljósgrjafann.

### IT:

#### Sorgente luminosa:

La sorgente luminosa non è intercambiabile perché è saldamente collegata al prodotto per via del suo design.



Questo prodotto contiene una sorgente luminosa di classe di efficienza energetica <G>.

   La sorgente luminosa a LED non può essere sostituita.

### LT:

#### Šviesos šaltinis:

Šis šviesos šaltinis yra nekeičiamas, nes jis prijungtas prie gaminio pagal jo konstrukciją. Šiame gaminyje yra šviesos šaltinis, kurio energijos vartojimo efektyvumo klasė <G>.

   LED šviesos šaltinis yra nekeičiamas.

### LV:

#### Gaismas avots:

Gaismas avots nevar nomainīt, jo tas konstrukcijā ir cieši savienots ar izstrādājuma apkārtejo daļu.

Šis ražojums satur gaismas avotu, kura energoefektivitātes klase ir <G>.



   LED apgaismes līdzekli nevar nomainīt.

### NL:

#### Lichtbron:

De lichtbron kan niet worden vervangen, omdat deze vanwege de constructie vast met het product eromheen verbonden is.

Dit product bevat een lichtbron van energie-efficiëntieklasse <G>.

   De LED-lichtbron kan niet worden vervangen.

### NO:

#### Lyskilde:

Lyskilden kan ikke byttes fordi den sitter fast i produktet.

Dette produktet inneholder en lyskilde i energiklasse <G>.

   LED-lyspæren kan ikke byttes.

### RO:

#### Sursa de lumina:

Sursa de lumina nu este inlocuibilă ea fiind parte constructivă a produsului Acest produs conține o sursă de lumină cu clasa de eficiență energetică <G>.

   Sursa de lumina nu poate fi înlocuită

### RUS:

#### Источник света:

Источник света не является взаимозаменяемым, поскольку это определяется конструкцией смежного продукта.

Данный продукт содержит источник света класса энергоэффективности <G>.

   Светодиодный источник света не подлежит замене.

### SE:

#### Ljuskälla:

Ljuskällan är inte utbytbar, eftersom den på grund av konstruktionen är fast integrerad i den omgivande produkten.

Denna produkt innehåller en ljuskälla med energieffektivitetsklass <G>.

   LED-ljuskällan kan inte bytas ut.

**RO:**Sursa de lumina:

Sursa de lumina nu este inlocuibilă ea fiind parte constructivă a produsului. Acest produs conține o sursă de lumină cu clasa de eficiență energetică <G>.

 Sursa de lumina nu poate fi înlocuită.

**RUS:**Источник света:

Источник света не является взаимозаменяемым, поскольку это определяется конструкцией смежного продукта. Данный продукт содержит источник света класса энергоэффективности <G>.

 Светодиодный источник света не подлежит замене.

**SE:**Ljuskälla:

Ljuskällan är inte utbytbar, eftersom den på grund av konstruktionen är fast integrerad i den omgivande produkten. Denna produkt innehåller en ljuskälla med energieffektivitetsklass <G>.

 LED-ljuskällan kan inte bytas ut.

**SI:**Izvor svetlobe:

Vir svetlobe ni zamenljiv, ker je določen z zasnovo izdelka v okolici. Ta izdelek vsebuje svetlobni vir razreda energijske učinkovitosti <G>.

 Svetlobni vir ni mogoče zamenjati.

**SK:**Zdroj svetla:

Svetelný zdroj nie je možné vymeniť, pretože je vďaka svojej konštrukcii pevne spojený s produktom. Tento výrobok obsahuje svetelný zdroj triedy energetickej účinnosti <G>.

 Svetelný zdroj nie je vymeniteľný.

**SRB:**Izvor svetlosti:

Izvor svetlosti nije zamenljiv, jer je zbog svog dizajna čvrsto povezan sa proizvodom koji ga opkružuje. Ovaj proizvod sadrži izvor svetlosti klase energetske efikasnosti <G>.

 LED izvor svetlosti nije zamenljiv.

**TR:**Işık kaynağı:

Konstrüksiyon gereği çevreleyen ürün ile sabit bir şekilde bağlı olduğu için ışık kaynağı değiştirilemez. Bu ürün, <G> enerji sınıfından bir ışık kaynağına sahiptir.

 LED ışık kaynağı değiştirilemez.

**UK:**Джерело світла:

Джерело світла не можна обміняти, оскільки воно міцно пов'язане з навколишнім виробом завдяки своїй конструкції. Цей виріб містить джерело світла класу енергоефективності <G>.

 – джерело світлодіодного світла не можна замінювати.