

1x 12W LED DC12V
220-240V~ 50/60Hz

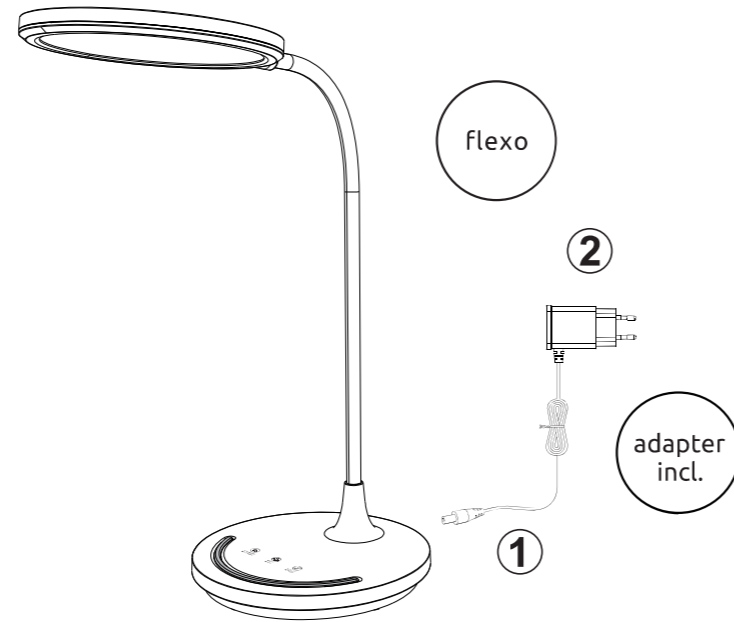

GLOBO Handels GmbH Gewerbestrasse 3, A-9148 Sankt Peter AUSTRIA
www.globo-lighting.com | office@globo-lighting.com

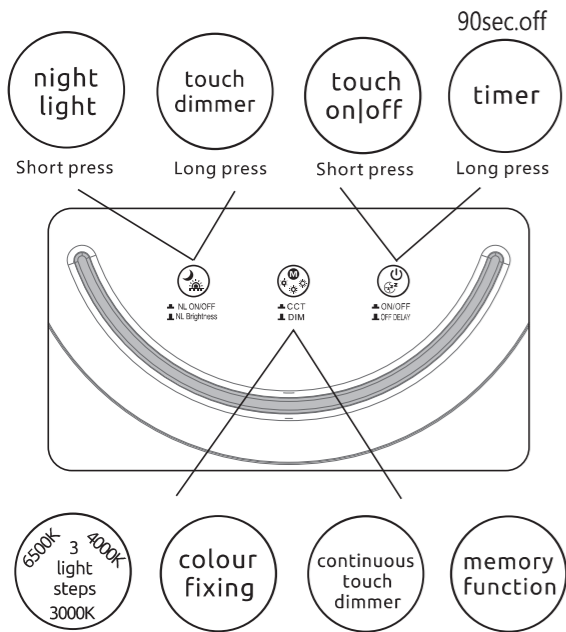
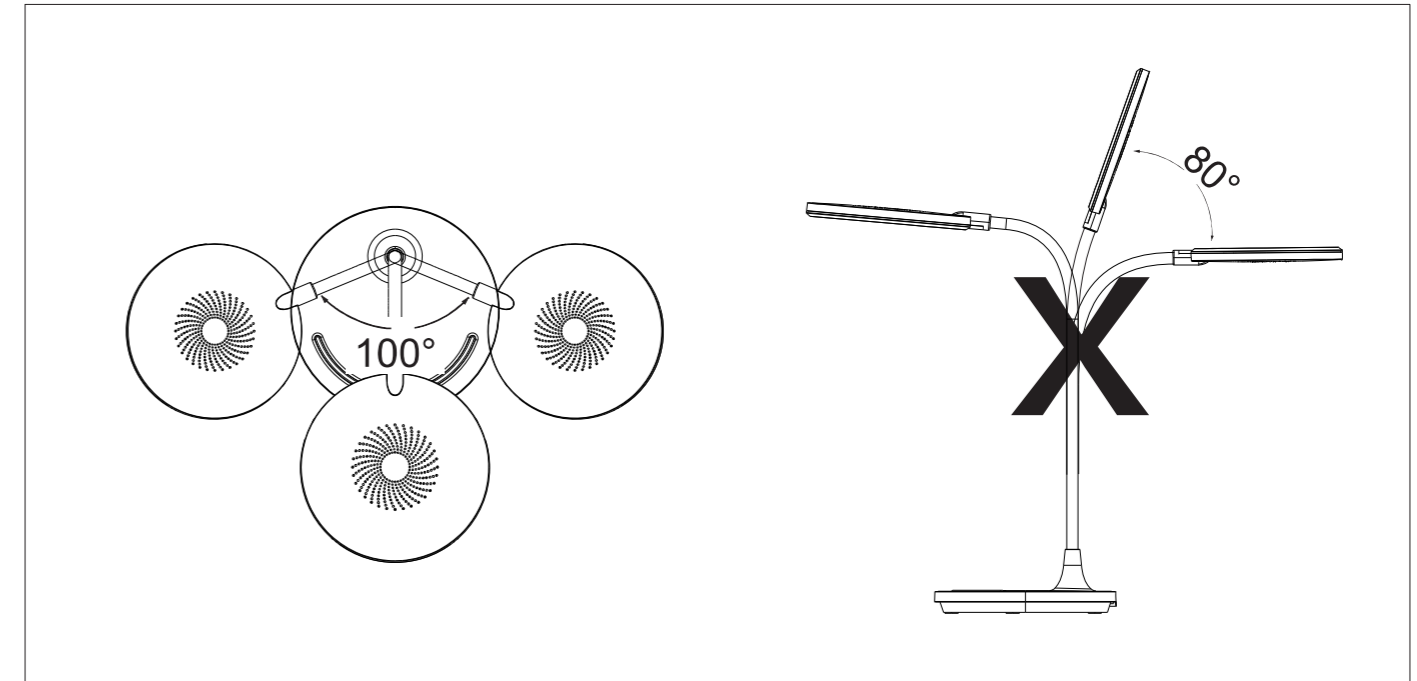

Anleitung zum Auswechseln der LEDs / Instruction how to change the LEDs

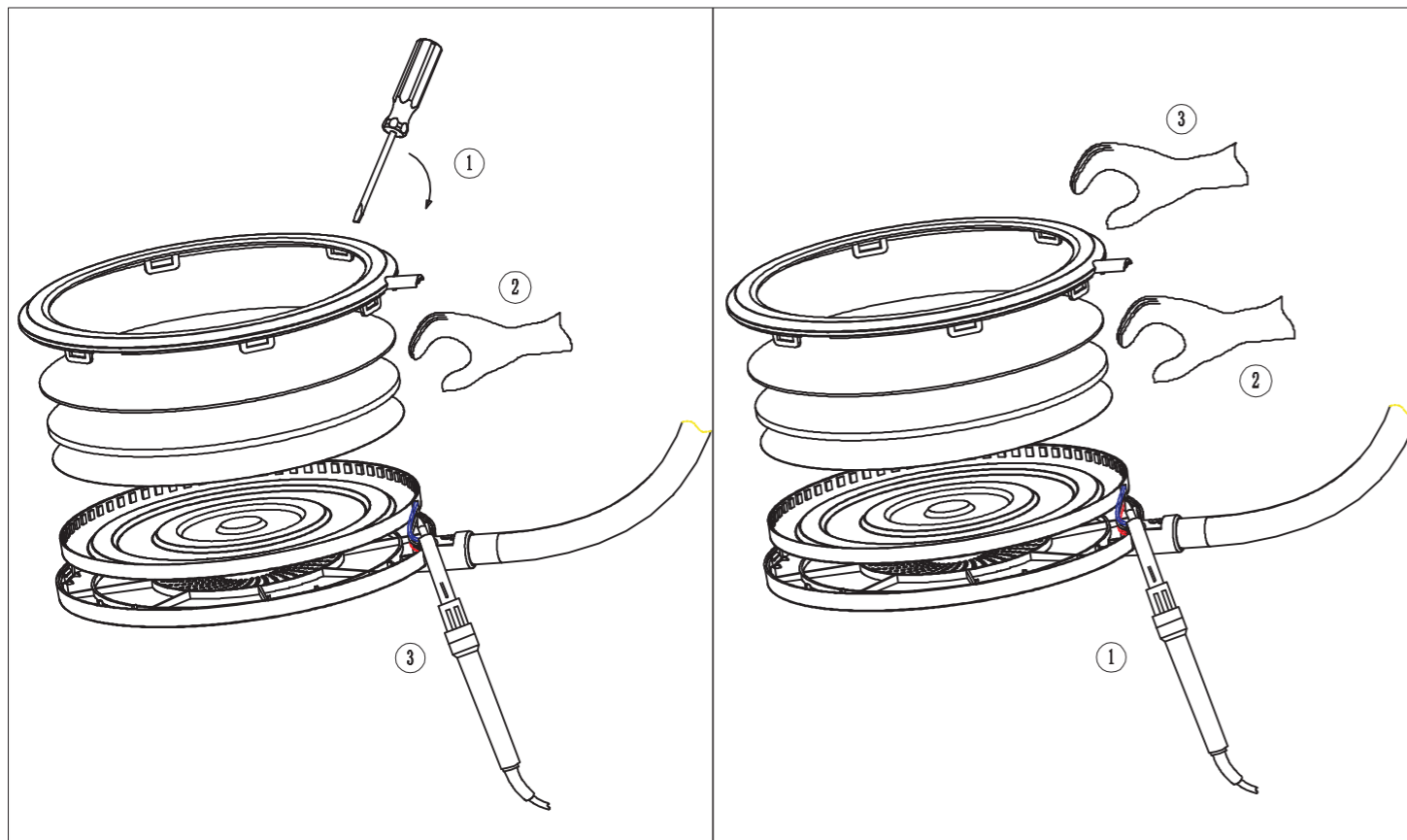

Lichtquelle/Light source:

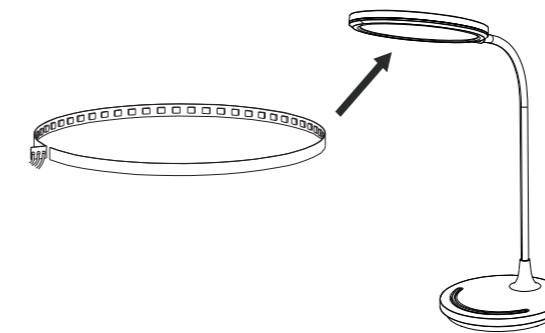

DEU: Lichtquelle:

Dieses Produkt enthält eine Lichtquelle der Energieeffizienzklasse <F>.



Die LED - Lichtquelle kann nur durch einen Fachmann ausgetauscht werden.

Das Betriebsgerät kann durch den Endkunden ausgetauscht werden.

GBR: Light source:

This product contains a light source of energy efficiency class <F>.



The LED - light source can only be replaced by a professional.

The control gear can be replaced by an end-user.

BGR:

Източник на светлина:

Този продукт включва светлинен източник с клас на енергийна ефективност <F>.



LED източникът на светлина може да се подменя само от специалист.

Устройството за управление може да се подменя от крайния клиент.

CZE:

Zdroj světla:

Tento výrobek obsahuje světelný zdroj s třídou energetické účinnosti <F>.



Výměna světelného LED zdroje pouze odborníkem.

Výměna předřadníku koncovým uživatelem.

DNK:

Lyskilde:

Dette produkt indeholder en lyskilde i energieeffektivitetsklasse <F>.



LED- lyskilden kan kun skiftes af en fagperson.

Driftsenheden kan skiftes af slutkunden.

ESP:

Fuente de luz:

Este producto contiene una fuente luminosa de la clase de eficiencia energética <F>.

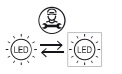

Sustitución del chip LED por un profesional.



Sustitución del aparato por parte del cliente final

EST:

Valgusallikas:

Toode sisaldab energiatõhususe klassi <F> valgusallikat.



LED - valgusallikat võib vahetada ainult professionaal.



Juhtseadme võib asendada lõppkasutaja.

EL/GRE:

Φωτεινή πηγή:

Το προϊόν αυτό περιέχει φωτεινή πηγή της τάξης ενεργειακής απόδοσης <F>.

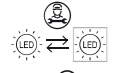

Η φωτεινή πηγή LED μπορεί να αντικατασταθεί μόνο από έναν ειδικό.



Η λειτουργική συσκευή μπορεί να αντικατασταθεί από τον τελικό πελάτη.

FIN:

Valonlähde:

Tämä tuote sisältää valonlähteen, jonka energiatehokkuusluokka on <F>.



Vain ammattihenkilö voi vaihtaa LED-valonlähteen.

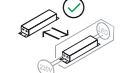

Loppuasiakas voi vaihtaa liitäntälaitteen.

FRA:

Source lumineuse:

Ce produit contient une source lumineuse de classe d'efficacité énergétique <F>.

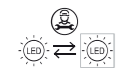

La source lumineuse LED ne peut être remplacée que par un spécialiste.

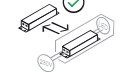

L'unité de contrôle peut être remplacée par le client final.

HRV :

Izvor svjetla :

Ovaj proizvod sadržava izvor svjetlosti klase energetske učinkovitosti <F>.

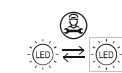

LED – izvor svjetla smije zamjeniti samo stručna osoba.

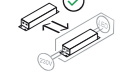

Pogonski uređaj može zamjeniti krajnji korisnik.

HUN:

Fényforrás:

Ez a termék egy <F> energiahatékonysági osztályú fényforrást tartalmaz.

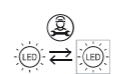

A LED fényforrás cseréjét csak szakemberek végezhetik.

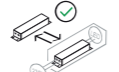

Az előtét végfelhasználói cseréje.

ISL:

Ljósgrjafi:

Varan inniheldur ljósgrjafa í orkuflokki <F>.

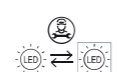

Aðeins fagmenn mega skipta um LED-ljósgrjafann.



Endanotandi má skipta um stjórnbúnað.

ITA:

Sorgente luminosa:

Questo prodotto contiene una sorgente luminosa di classe di efficienza energetica <F>.

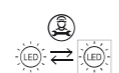

La sorgente luminosa a LED può essere sostituita solo da personale specializzato.



La centralina può essere sostituita dall'utente finale.

LT:

Šviesos šaltinis:

Šiame gaminyje yra šviesos šaltinis, kurio energijos vartojimo efektyvumo klasė <F>.



LED šviesos šaltinį gali pakeisti tik tam kvalifikuotas specialistas.

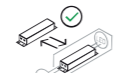

Valdymo įtaisą gali pakeisti galutinis vartotojas.

LVA:

Gaismas avots:

Šis ražojums satur gaismas avotu, kura energoefektivitātes klase ir <F>.

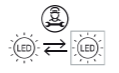

LED apgaismes līdzekli var nomainīt speciālists.

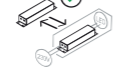

Vadības ierīci var nomainīt gala klients.

NL:

Lichtbron:

Dit product bevat een lichtbron van energie-efficiëntieklasse <F>.



De LED-lichtbron kan alleen door een vakman worden vervangen.

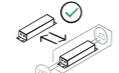

Het apparaat kan door de consument worden vervangen.

NOR:

Lyskilde:

Dette produktet inneholder en lyskilde i energiklasse <F>.

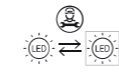

LED-lyspæren kan kun byttes av fagmann.

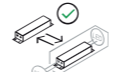

Driverenheten kan byttes av sluttbrukeren.

PL:

Źródło światła:

Ten produkt zawiera źródło światła o klasie efektywności energetycznej <F>.

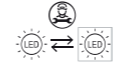

LED - źródło światła może być wymienione tylko przez profesjonalistę.



Urządzenie sterujące może zostać wymienione przez użytkownika końcowego.

POR:

Fonte de Luz:

Este produto contém uma fonte de luz da classe de eficiência energética <F>.

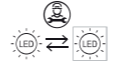

Substituição da LED por um profissional.

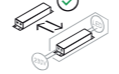

Substituição do dispositivo operacional pelo cliente final.

RO:

Sursa de lumina:

Acest produs conține o sursă de lumină cu clasa de eficiență energetică <F>.



Sursa LED poate fi înlocuită/schimbata doar de către personal specializat.



Driverul poate fi înlocuit de către utilizator

RUS:

Источник света:

Данный продукт содержит источник света класса энергоэффективности <F>.



Светодиодный источник света может заменяться только квалифицированным специалистом.



Устройство управления может заменяться конечным потребителем.

SK:

Zdroj svetla:

Tento výrobok obsahuje svetelný zdroj triedy energetickej účinnosti <F>.

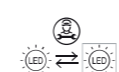

Výmena svetelného LED zdroja len odborníkom.



Výmena predradníka koncovým užívateľom.

SRB:

Izvor svetlosti:

Ovaj proizvod sadrži izvor svetlosti klase energetske efikasnosti <F>.

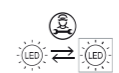

LED izvor svetlosti može da zameni samo specijalista.



Upravljački uređaj može da zameni krajnji kupac.

SWE:

Ljuskälla:

Denna produkt innehåller en ljuskälla med energieffektivitetsklass <F>.



LED-ljuskällan kan endast bytas ut av en fackman.

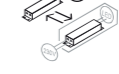

Slutkunden kan byta ut driftdonet.

SI:

Izvor svetlobe:

Ta izdelek vsebuje svetlobni vir razreda energijske učinkovitosti <F>.

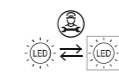

Svetlobni vir lahko zamenja samo strokovno usposobljena oseba.

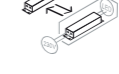

Krmilno napravo lahko zamejate sami.

TUR:

Işık kaynağı:

Bu ürün, <F> enerji sınıfından bir ışık kaynağına sahiptir.



LED ışık kaynağı, sadece bir uzman tarafından değiştirilebilir.



İşletme cihazı, son kullanıcı tarafından değiştirilebilir.

UA:

Джерело світла:

Цей виріб містить джерело світла класу енергоефективності <F>.



лише фахівець може замінювати джерело світлодіодного світла.



кінцевий споживач може замінювати пристрій керування.