

# GLOBO

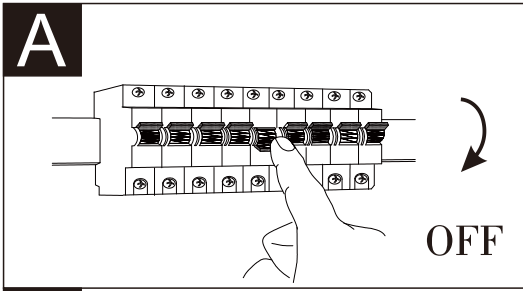

LIGHTING  
67333-70



**B**

LED MAX 70W 36V  
220-240V~ 50/60Hz

Frequency Bandwidth	Maximal radiation transmitting power
2412-2472MHz	10dBm

- dimmable
- night light
- timer
- colour fixing
- incl. 
- memory function
- many steps 
- 2700 K - 6500 K
- 4000 K **3** 6500 K  
LIGHT STEPS  
2700 K

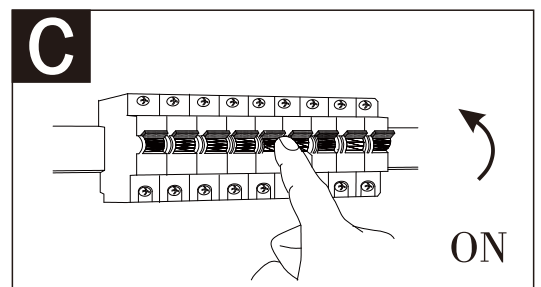
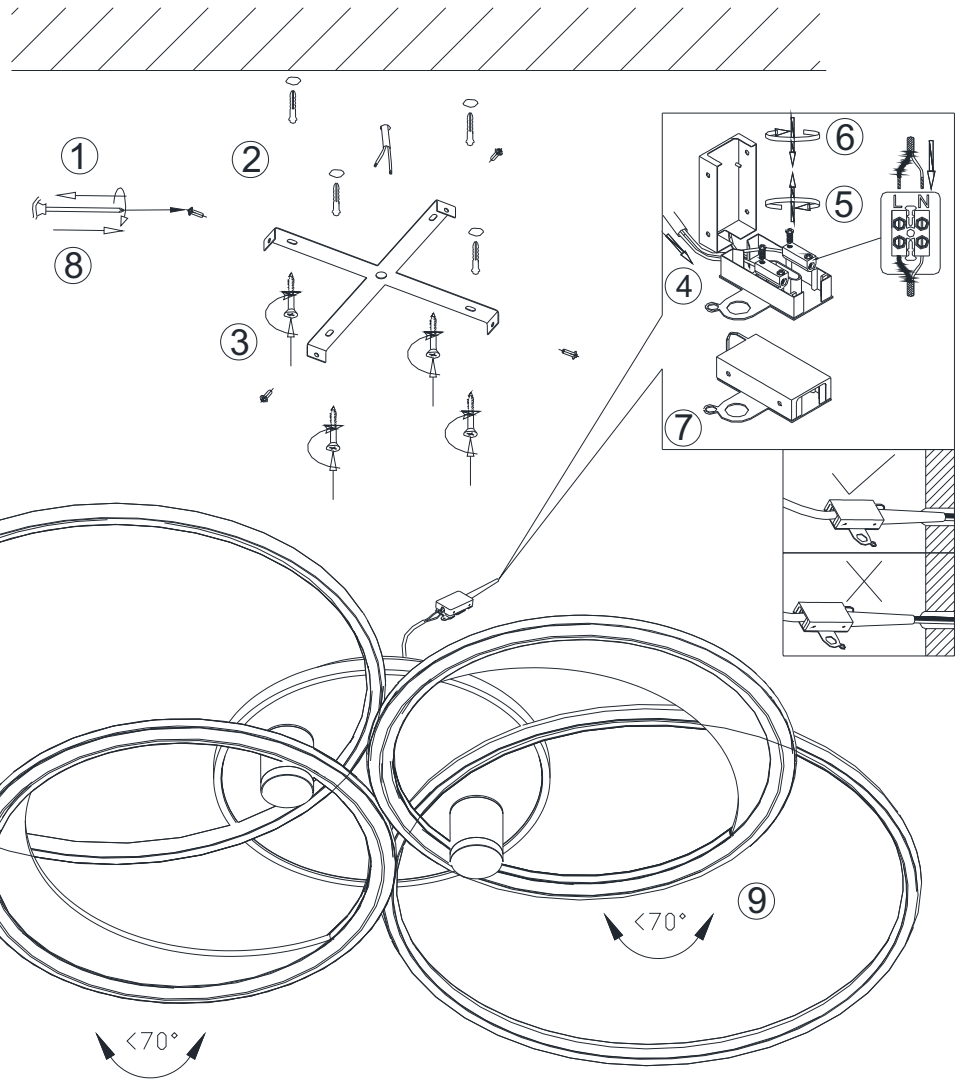

GLOBO Handels GmbH  
Gewerbestr. 3  
A-9184 Sankt Peter  
AUSTRIA  
www.globo-lighting.com  
office@globo-lighting.com

# Reset remote control

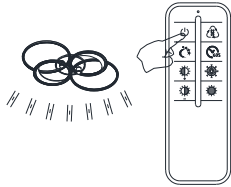
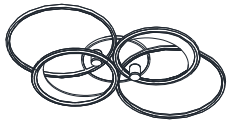

2~3S

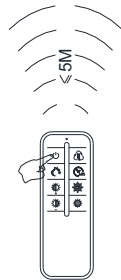
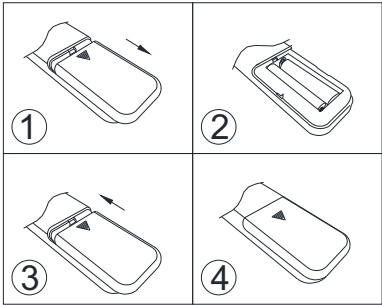
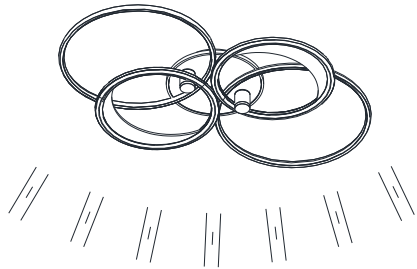

## BATTERY DATA

2x AAA battery\* incl.

\*Manufacturer: Gmcell Battery Technology Co., Ltd.  
Address: 2205&2206, Building G, Hualian City Panorama, 27 Dalang Community, Xin'an Street, Bao'an District, Shenzhen, Guangdong Province  
Model: P03P UM-4 1.5V

## SAFETY INSTRUCTIONS



ON/OFF



COLOUR FIXING

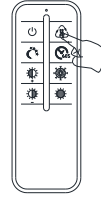

NIGHT LIGHT

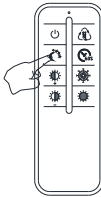

Timer 60sec.

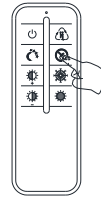

LM ↑



6500K ↑  
2700K



LM ↓

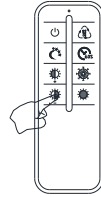

6500K ↓  
2700K



# Wall switch



2700K



T < 3sec.



4000K

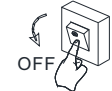

T < 3sec.



6500K



T < 3sec.



NIGHT LIGHT

## Lichtquelle/Light source

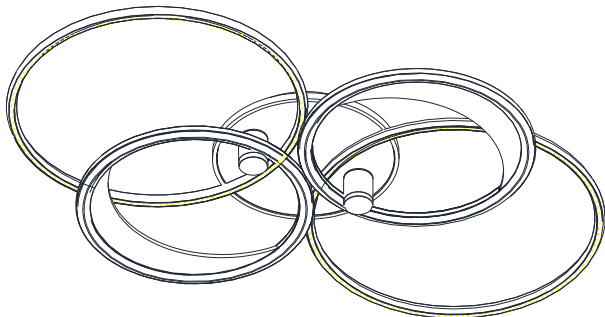

### DEU:

#### Lichtquelle:

Die Lichtquelle ist nicht tauschbar, weil sie konstruktionsbedingt fest mit dem umgebenden Produkt verbunden ist.

Dieses Produkt enthält eine Lichtquelle der Energieeffizienzklasse <E>.

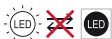

Die LED - Lichtquelle ist nicht austauschbar.

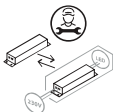

Das Betriebsgerät kann nur durch einen Fachmann ausgetauscht werden.

### GBR:

#### Light source:

The light source is not interchangeable because it is determined by the surrounding product design. This product contains a light source of energy efficiency class < E >.

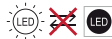

The LED - light source cannot be replaced.

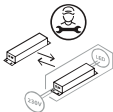

The control gear can be replaced by a professional.

### BGR:

#### Източник на светлина:

Източникът на светлина не може да се подменя, тъй като поради конструкцията си е трайно фиксиран към заобикалящия го продукт. Този продукт включва светлинен източник с клас на енергийна ефективност <E>.

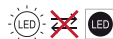

LED източникът на светлина не може да се подменя.



Устройството за управление може да се подменя само от специалист.

### CZE:

#### Zdroj světla:

Světelný zdroj není možné vyměnit, protože je díky své konstrukci pevně spojený s produktem.

Tento výrobek obsahuje světelný zdroj s třídou energetické účinnosti <E>.

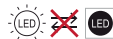

Světelný zdroj není vyměnitelný.

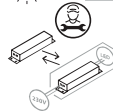

Výměna předřadníku pouze odborníkem

### DNK:

#### Lyskilde:

Lyskilden kan ikke udskiftes, fordi den er fast forbundet med det omgivende produkt.

Denne produkt indeholder en lyskilde i energieffektivitetsklasse < E >.

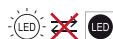

LED- lyskilden kan ikke udskiftes.

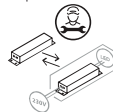

Driftsenheden kan kun skiftes af en fagperson.

**ESP:**

**Fuente de luz:**

La fuente de luz no es sustituible porque está fija en el producto desde la construcción.  
Este producto contiene una fuente luminosa de la clase de eficiencia energética <E>.

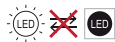

Bombilla no reemplazable.

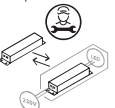

Sustitución del aparato por un profesional.

**EST:**

**Valgusallikas:**

Valgusallikas ei ole välja vahetatav, sest ta on tootega ehituslikult kindlalt seotud.  
Toode sisaldab energiatõhususe klassi <E> valgusallikat.

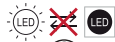

LED - valgusallikat ei saa asendada.

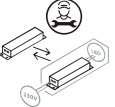

Juhtseadmed võib asendada professionaalne.

**EL/GRE:**

**Φωτεινή πηγή:**

Η φωτεινή πηγή δεν μπορεί να αντικατασταθεί, επειδή είναι για κατασκευαστικούς λόγους σταθερά συνδεδεμένη με το προϊόν που την περιβάλλει.  
Το προϊόν αυτό περιέχει φωτεινή πηγή της τάξης ενεργειακής απόδοσης <E>.

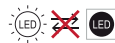

Η φωτεινή πηγή LED δεν αντικαθίσταται.

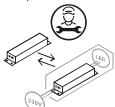

Η λειτουργική συσκευή μπορεί να αντικατασταθεί μόνο από έναν ειδικό.

**FIN:**

**Valonlähde:**

Valonlähdettä ei voi vaihtaa uuteen, sillä se on rakenteellisesti yhdistetty ympäröivään tuotteeseen.  
Tämä tuote sisältää valonlähteen, jonka energiatehokkuusluokka on <E>.



LED-valonlähdettä ei voi vaihtaa uuteen.

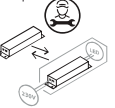

Vain ammattihenkilö voi vaihtaa liitäntälaitteen.

**FRA:**

**Source lumineuse:**

La source lumineuse n'est pas remplaçable car elle est, de par la construction du produit, liée de façon permanente à celui-ci.  
Ce produit contient une source lumineuse de classe d'efficacité énergétique <E>.



La source lumineuse LED n'est pas remplaçable.

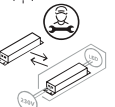

L'unité de contrôle ne peut être remplacée que par un spécialiste.

**BIH/HRV:**

**Izvor svjetla :**

Izvor svjetla nije zamjenjiv , jer je konstrukcijski pričvršćen na proizvod.  
Ovaj proizvod sadržava izvor svjetlosti klase energetske učinkovitosti <E>.

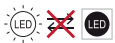

LED – izvor svjetla nije moguće zamjeniti

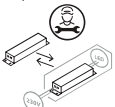

Pogonski uređaj smije zamjeniti samo stručna osoba .

**HUN:**

**Fényforrás:**

A fényforrás nem cserélhető, mert felépítése miatt szilárdan csatlakozik a termékhez

Ez a termék egy <E> energiahatékonysági osztályú fényforrást tartalmaz.

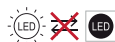

A fényforrás nem cserélhető

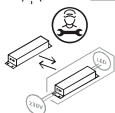

Az előtétet csak szakértők cserélhetik ki.

**ISL:**

**Ljósgrjafi:**

Ljósgrjafinn er ekki útskiptanlegur vegna þess að hann er háður umliggjandi hönnun vörunnar.

Varan inniheldur ljósgrjafa í orkuflokki <E>.

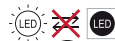

Ekki er hægt að skipta um LED-ljósgrjafann.

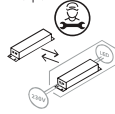

Aðeins fagmenn mega skipta um stjórnbúnaðinn..

**ITA:**

**Sorgente luminosa:**

La sorgente luminosa non è intercambiabile perché è saldamente collegata al prodotto per via del suo design.

Questo prodotto contiene una sorgente luminosa di classe di efficienza energetica <E>.

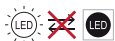

La sorgente luminosa a LED non può essere sostituita.



L'alimentatore può essere sostituito solo da personale

**LT:**

**Šviesos šaltinis:**

Šis šviesos šaltinis yra nekeičiamas, nes jis prijungtas prie gaminio pagal jo konstrukciją.

Šiame gaminyje yra šviesos šaltinis, kurio energijos vartojimo efektyvumo klasė <E>.



LED šviesos šaltinis yra nekeičiamas.

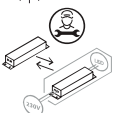

Valdymo įtaisa gali pakeisti tik tam kvalifikuotas

**LVA:**

**Gaismas avots:**

Gaismas avotu nevar nomainīt, jo tas konstrukcijā ir cieši savienots ar izstrādājuma apkārtējo daļu.

Šis ražojums satur gaismas avotu, kura energoefektivitātes klase ir <E>.



LED apgaismes līdzekli nevar nomainīt.

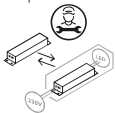

Vadības ierīci var nomainīt speciālists.

**NL:**

**Lichtbron:**

De lichtbron kan niet worden vervangen, omdat deze vanwege de constructie vast met het product eromheen verbonden is.

Dit product bevat een lichtbron van energie-efficiëntieklasse <E>.



De LED-lichtbron kan niet worden vervangen.

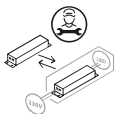

Het apparaat kan alleen door een vakman worden vervangen.

**NOR:**

**Lyskilde:**

Lyskilden kan ikke byttes fordi den sitter fast i produktet.  
Dette produktet inneholder en lyskilde i energiklasse <E>.

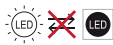

LED-lyspæren kan ikke byttes.

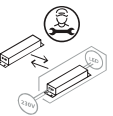

Driverenheten kan kun byttes av fagmann.

**PL:**

**Źródło światła:**

Źródła światła nie można wymienić, ponieważ jest zintegrowane z produktem ze względu na swoją konstrukcję.  
Ten produkt zawiera źródło światła o klasie efektywności energetycznej <E>.

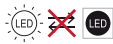

LED - źródło światła nie może być wymienione.

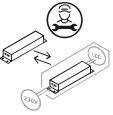

Urządzenie sterujące może zostać wymienione przez

**POR:**

**Fonte de Luz:**

A fonte de luz não é substituível porque devido às suas características construtivas está fixada de forma permanente ao produto circundante.  
Este produto contém uma fonte de luz da classe de eficiência energética <E>.



Lâmpada não substituível.

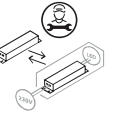

Substituição do equipamento de controlo por um profissional.

**RO**

**Sursa de lumina:**

Sursa de lumina nu este inlocuibilă ea fiind parte constructivă a produsului  
Acest produs conține o sursă de lumină cu clasa de eficiență energetică <E>.



Sursa de lumina nu poate fi înlocuită

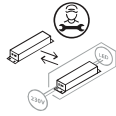

Driverul poate fi înlocuit doar de către personal specializat

**RUS:**

**Источник света:**

Источник света не является взаимозаменяемым, поскольку это определяется конструкцией смежного продукта.  
Данный продукт содержит источник света класса энергоэффективности <E>.

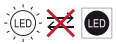

Светодиодный источник света не подлежит замене.

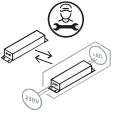

Устройство управления может заменяться только квалифицированным специалистом.

**SK:**

**Zdroj svetla:**

Svetelný zdroj nie je možné vymeniť, pretože je vďaka svojej konštrukcii pevne spojený s produktom.  
Tento výrobok obsahuje svetelný zdroj triedy energetickej účinnosti <E>.

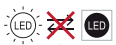

Svetelný zdroj nie je vymeniteľný.

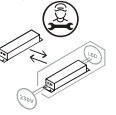

Výmena predradníka len odborníkom.

**SRB:**

Izvor svetlosti:

Izvor svetlosti nije zamenljiv, jer je zbog svog dizajna čvrsto povezan sa proizvodom koji ga opkružuje.

Ovaj proizvod sadrži izvor svetlosti klase energetske efikasnosti <E>.

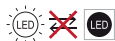

LED izvor svetlosti nije zamenljiv.

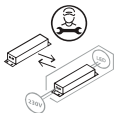

Upravljački uređaj može da zameni samo specijalista.

**SWE**

Ljuskälla:

Ljuskällan är inte utbytbar, eftersom den på grund av konstruktionen är fast integrerad i den omgivande produkten.

Denna produkt innehåller en ljuskälla med energieffektivitetsklass <E>.

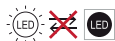

LED-ljuskällan kan inte bytas ut.

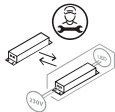

Driftdonet kan endast bytas ut av en fackman.

**SI:**

Izvor svetlobe:

Vir svetlobe ni zamenljiv, ker je določen z zasnovno izdelka v okolici.

Ta izdelek vsebuje svetlobni vir razreda enerjske učinkovitosti <E>.

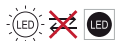

Svetlobni vir ni mogoče zamenjati.

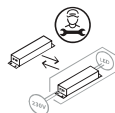

Krmilno napravo lahko zamenja samo strokovno usposobljena oseba

**TUR:**

Işık kaynağı:

Konstrüksiyon gereği çevreleyen ürün ile sabit bir şekilde bağlı olduğu için ışık kaynağı değiştirilemez. Bu ürün, <E> enerji sınıfından bir ışık kaynağına sahiptir.



LED ışık kaynağı değiştirilemez.

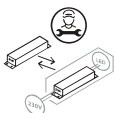

İşletme cihazı sadece bir uzman tarafından değiştirilebilir.

**UA:**

Джерело світла:

Джерело світла не можна обміняти, оскільки воно міцно пов'язане з навколишнім виробом завдяки своїй конструкції.

Цей виріб містить джерело світла класу енергоефективності <E>.

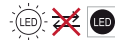

– джерело світлодіодного світла не можна замінювати.

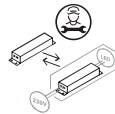

– лише фахівець може замінювати пристрій керування.