

# GLOBO

LIGHTING

67849S

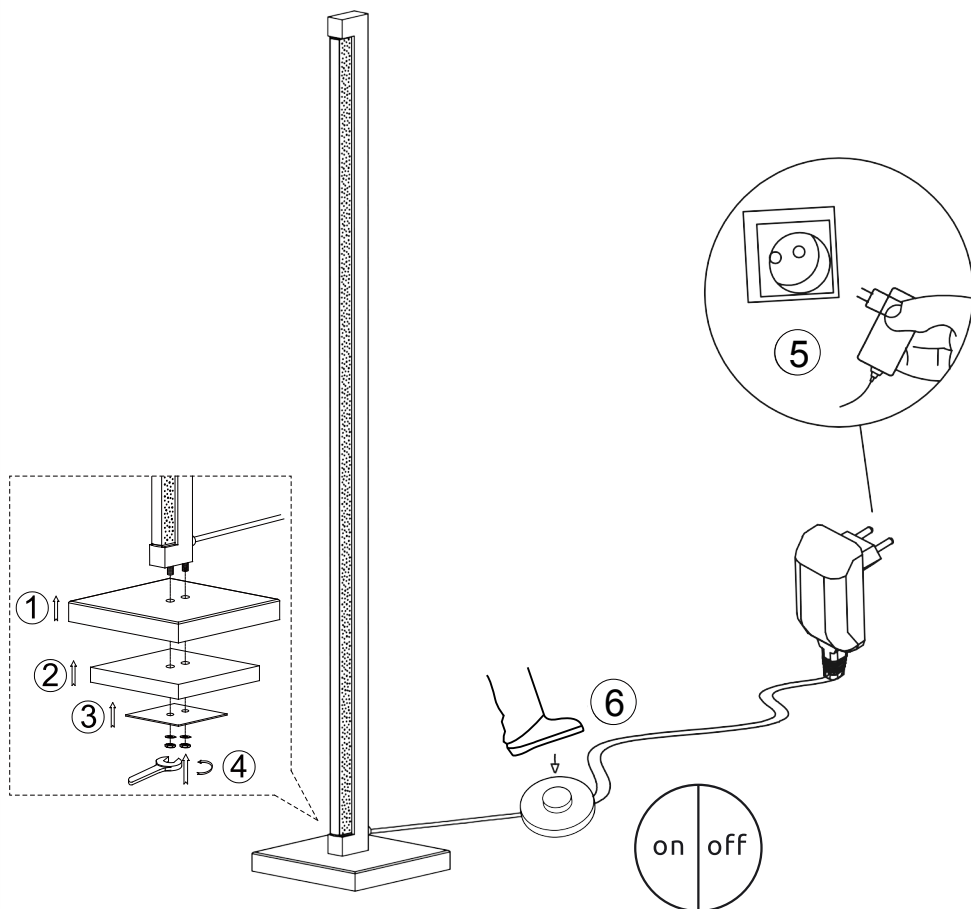

LED MAX 23.5W DC24V  
220-240V~ 50/60Hz

GLOBO Handels GmbH  
Gewerbestr. 3

A-9184 Sankt Peter, AUSTRIA

www.globo-lighting.com | office@globo-lighting.com

Lichtquelle/Light source:

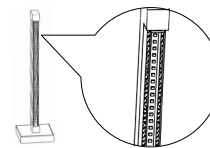



**DEU:**

Lichtquelle:

Die Lichtquelle ist nicht tauschbar, weil sie konstruktionsbedingt fest mit dem umgebenden Produkt verbunden ist.

Dieses Produkt enthält eine Lichtquelle der Energieeffizienzklasse <F>.

  Die LED - Lichtquelle ist nicht austauschbar.



 Das Betriebsgerät kann nur durch einen Fachmann ausgetauscht werden.

**GBR:**

Light source:

The light source is not interchangeable because it is determined by the surrounding product design.

This product contains a light source of energy efficiency class <F>.

  The LED - light source cannot be replaced.

 The control gear can be replaced by a professional.

**BIH & HR:**

Izvor svjetla :

Izvor svjetla nije zamjenjiv , jer je konstrukcijski pričvršćen na proizvod .

Ovaj proizvod sadržava izvor svjetlosti klase energetske učinkovitosti <F>.

  LED – izvor svjetla nije moguće zamjeniti

 Pogonski uređaj smije zamjeniti samo stručna osoba .

**BG:**

Източник на светлина:

Източникът на светлина не може да се подменя, тъй като поради конструкцията си е трайно фиксиран към заобикалящия го продукт.

Този продукт включва светлинен източник с клас на енергийна ефективност <F>.

  LED източникът на светлина не може да се подменя.



 Устройството за управление може да се подменя само от специалист.

**CZ:**

Zdroj světla:

Světelný zdroj není možné vyměnit, protože je díky své konstrukci pevně spojený s produktem.

Tento výrobek obsahuje světelný zdroj s třídou energetické účinnosti <F>.

  Světelný zdroj není vyměnitelný.

 Výměna předřadníku pouze odborníkem

**DK:**

Lyskilde:

Lyskilden kan ikke udskiftes, fordi den er fast forbundet med det omgivende produkt.

Dette produkt indeholder en lyskilde i energieffektivitetsklasse <F>.

  LED- lyskilden kan ikke udskiftes.



 Driftsenheden kan kun skiftes af en fagperson.

**ET:**

Valgusallikas:

Valgusallikas ei ole välja vahetatav, sest ta on tootega ehituslikult kindlalt seotud.

Toode sisaldab energiatõhususe klassi <F> valgusallikat.

  LED - valgusallikat ei saa asendada.



 Juhtseadmed võib asendada professionaalne.

**FI:**

Valonlähde:

Valonlähdettä ei voi vaihtaa uuteen, sillä se on rakenteellisesti yhdistetty ympäröivään tuotteeseen.

Tämä tuote sisältää valonlähteen, jonka energiatehokkuusluokka on <F>.

  LED-valonlähdettä ei voi vaihtaa uuteen.

 Vain ammattihenkilö voi vaihtaa liitäntälaitteen.

**FR:**

Source lumineuse:



La source lumineuse n'est pas remplaçable car elle est, de par la construction du produit, liée de façon permanente à celui-ci. Ce produit contient une source lumineuse de classe d'efficacité énergétique <F>.



  La source lumineuse LED n'est pas remplaçable.

 L'unité de contrôle ne peut être remplacée que par un spécialiste.

**GR:**Φωτεινή πηγή:

Η φωτεινή πηγή δεν μπορεί να αντικατασταθεί, επειδή είναι για κατασκευαστικούς λόγους σταθερά συνδεδεμένη με το προϊόν που την περιβάλλει. Το προϊόν αυτό περιέχει φωτεινή πηγή της τάξης ενεργειακής απόδοσης <F>.



  Η φωτεινή πηγή LED δεν αντικαθίσταται.

  Η λειτουργική συσκευή μπορεί να αντικατασταθεί μόνο από έναν ειδικό.

**HU:**Fényforrás:

A fényforrás nem cserélhető, mert felépítése miatt szilárdan csatlakozik a termékhez. Ez a termék egy <F> energiatékonysági osztályú fényforrást tartalmaz.



  A fényforrás nem cserélhető



  Az előtétet csak szakértők cserélhetik ki.

**IS:**Ljósgefafi:

Ljósgefafinn er ekki útskiptanlegur vegna þess að hann er háður umliggjandi hönnun vörunnar.



Varan inniheldur ljósgefafa í orkuflokki <F>.



  Ekki er hægt að skipta um LED-ljósgefafann.

  Aðeins fagmenn mega skipta um stjórnbúnaðinn.

**IT:**Sorgente luminosa:

La sorgente luminosa non è intercambiabile perché è saldamente collegata al prodotto per via del suo design. Questo prodotto contiene una sorgente luminosa di classe di efficienza energetica <F>.



  La sorgente luminosa a LED non può essere sostituita.

  L'alimentatore può essere sostituito solo da personale specializzato.

**LV:**Gaismas avots:

Gaismas avotu nevar nomainīt, jo tas konstrukcijā ir cieši savienots ar izstrādājuma apkārtējo daļu. Šis ražojums satur gaismas avotu, kura energoefektivitātes klase ir <F>.



  LED apgaismes līdzekli nevar nomainīt.



  Vadības ierīci var nomainīt speciālists.

**LT:**Šviesos šaltinis:

Šis šviesos šaltinis yra nekeičiamas, nes jis prijungtas prie gaminių pagal jo konstrukciją.



Šiame gaminyje yra šviesos šaltinis, kurio energijos vartojimo efektyvumo klasė <F>.



  LED šviesos šaltinis yra nekeičiamas.

  Valdymo įtaisą gali pakeisti tik tam kvalifikuotas specialistas.

**NL:**Lichtbron:



De lichtbron kan niet worden vervangen, omdat deze vanwege de constructie vast met het product eromheen verbonden is. Dit product bevat een lichtbron van energie- efficiëntieklasse <F>.



  De LED-lichtbron kan niet worden vervangen.

  Het apparaat kan alleen door een vakman worden vervangen.

**NO:**Lyskilde:



Lyskilden kan ikke byttes fordi den sitter fast i produktet. Dette produktet inneholder en lyskilde i energiklasse <F>.



  LED-lyspæren kan ikke byttes.

  Driverenheten kan kun byttes av fagmann.

**PL:**Źródło światła:



Źródła światła nie można wymienić, ponieważ jest zintegrowane z produktem ze względu na swoją konstrukcję. Ten produkt zawiera źródło światła o klasie efektywności energetycznej <F>.



  LED - źródło światła nie może być wymienione.

  Urządzenie sterujące może zostać wymienione przez specjalistę.

**PT:**Fonte de Luz:



A fonte de luz não é substituível porque devido às suas características construtivas está fixada de forma permanente ao produto circundante. Este produto contém uma fonte de luz da classe de eficiência energética <F>.



  Lâmpada não substituível.

  Substituição do equipamento de controlo por um profissional.

**RO:**Sursa de lumina:



Sursa de lumina nu este inlocuibilă ea fiind parte constructivă a produsului. Acest produs conține o sursă de lumină cu clasa de eficiență energetică <F>.



  Sursa de lumina nu poate fi înlocuită

  Driverul poate fi înlocuit doar de către personal specializat.

**RUS:**Источник света:



Источник света не является взаимозаменяемым, поскольку это определяется конструкцией смежного продукта. Данный продукт содержит источник света класса энергоэффективности <F>.



  Светодиодный источник света не подлежит замене.

  Устройство управления может заменяться только квалифицированным специалистом.

**SRB:**Izvor svetlosti:



Izvor svetlosti nije zamenljiv, jer je zbog svog dizajna čvrsto povezan sa proizvodom koji ga opkružuje. Ovaj proizvod sadrži izvor svetlosti klase energetske efikasnosti <F>.



  LED izvor svetlosti nije zamenljiv.

  Upravljački uređaj može da zameni samo specijalista.

**SK:**Zdroj svetla:



Svetelný zdroj nie je možné vymeniť, pretože je vďaka svojej konštrukcii pevne spojený s produktom. Tento výrobok obsahuje svetelný zdroj triedy energetickej účinnosti <F>.



  Svetelný zdroj nie je vymeniteľný.

  Výmena predradníka len odborníkom.

**SI:**Izvor svetlobe:



Vir svetlobe ni zamenljiv, ker je določen z zasnovno izdelka v okolici. Ta izdelek vsebuje svetlobni vir razreda energijske učinkovitosti <F>.



  Svetlobni vir ni mogoče zamenjati.

  Krmilno napravo lahko zamenja samo strokovno usposobljena oseba.

**ES:**Fuente de luz:

La fuente de luz no es sustituible porque está fija en el producto desde la construcción. Este producto contiene una fuente luminosa de la clase de eficiencia energética <F>.



  Bombilla no reemplazable.



  Sustitución del aparato por un profesional.

**SE:**Ljuskälla:

Ljuskällan är inte utbytbar, eftersom den på grund av konstruktionen är fast integrerad i den omgivande produkten.

Denna produkt innehåller en ljuskälla med energieffektivitetsklass <F>.



  LED-ljuskällan kan inte bytas ut.



  Driftdonet kan endast bytas ut av en fackman.

**TR:**Işık kaynağı:

Konstrüksiyon gereği çevreleyen ürün ile sabit bir şekilde bağlı olduğu için ışık kaynağı değiştirilemez.

Bu ürün, <F> enerji sınıfından bir ışık kaynağına sahiptir.



  LED ışık kaynağı değiştirilemez.



  İşletme cihazı sadece bir uzman tarafından değiştirilebilir.

**UK:**Джерело світла:

Джерело світла не можна обміняти, оскільки воно міцно пов'язане з навколишнім виробом завдяки своїй конструкції.

Цей виріб містить джерело світла класу енергоефективності <F>.

  Джерело світлодіодного світла не можна замінювати.

  лише фахівець може замінювати пристрій керування