

B152571

1

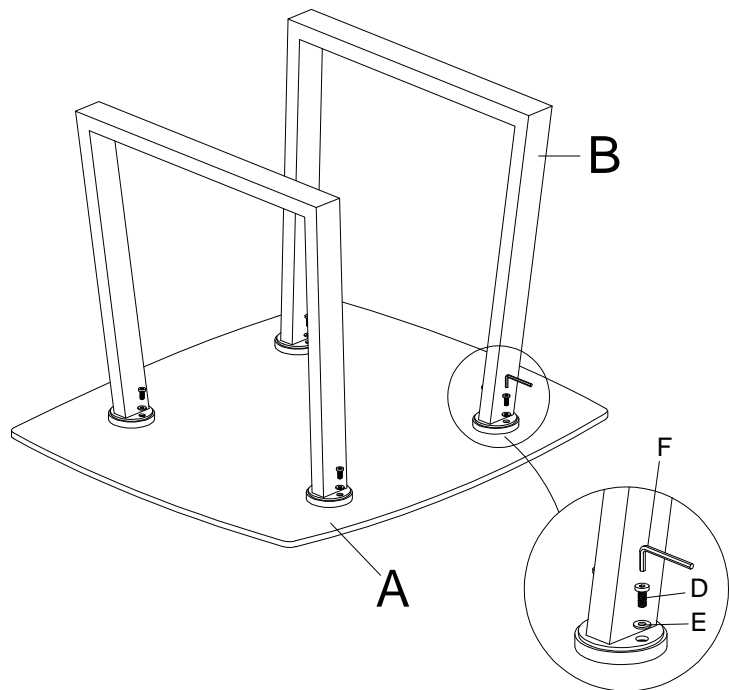

2

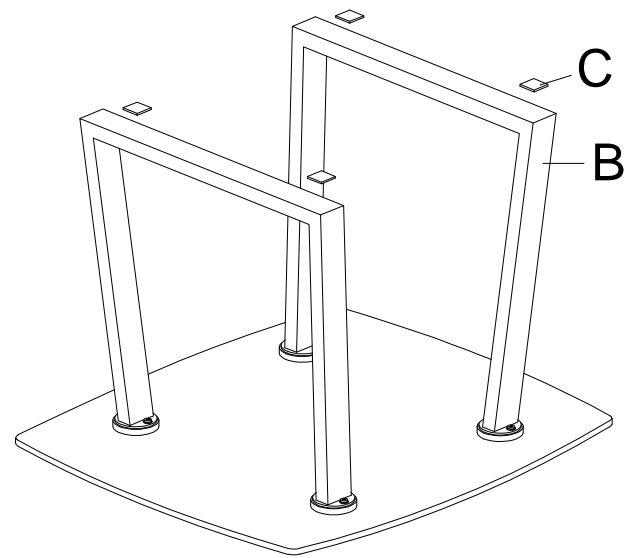

3



A		1	D		8
B		2	E		8
C		4	F		1