







#	①	②	③	④	⑤	⑥
P A R T S						
QTY	2	6	12	8	8	1

**A**



**B**

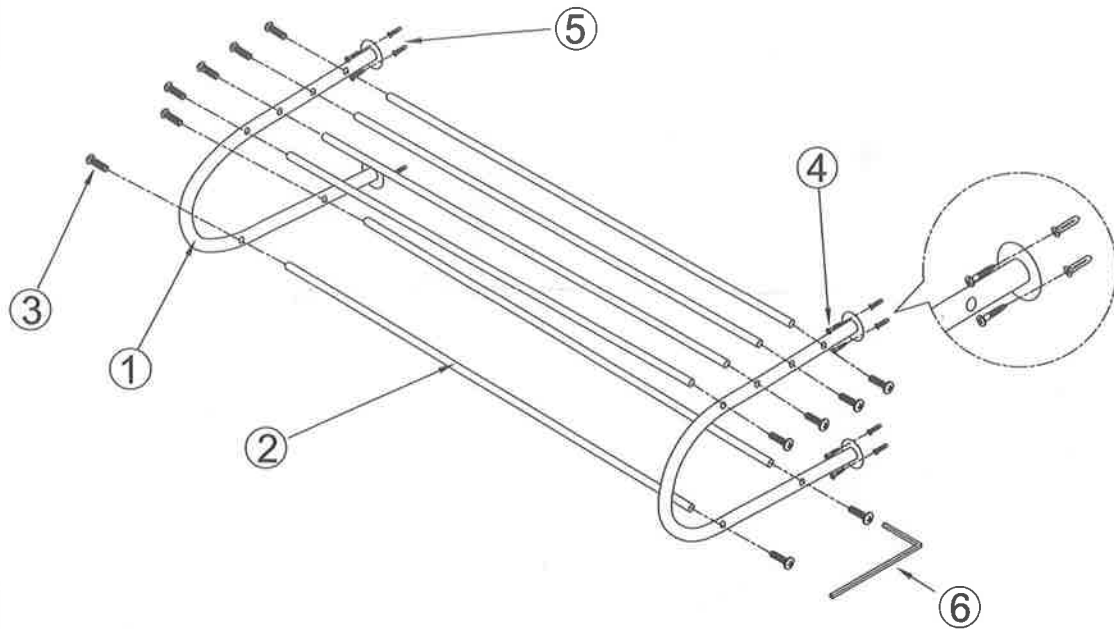